

304 159 / 304 160

ATTENTION : (pour connaître les caractéristiques d'utilisation consulter la carte grise).

Installé suivant nos recommandations, cet attelage vous donnera entière satisfaction. Nous dégageons toute responsabilité en cas de transformation ou d'utilisation illicite de celui-ci

FR

ACHTUNG: (Nutzungsmerkmale : siehe Fahrzeugschein)

Diese Anhängervorrichtung wird Sie voll zufrieden stellen, wenn Sie unsere Montageanleitung befolgen. Im Falle der unerlaubten Veränderung oder des unerlaubten Gebrauchs lehnen wir jede Haftung ab.

DE

PLEASE NOTE : (to familiarise yourself with the operating characteristics refer to the log).

If this tow bar is fitted in accordance with our recommendations it will give a completely satisfaction. We cannot accept any responsibility in the event of changes to or improper use of this item.

EN

BEMÆRK : (for yderligere oplysninger om anvendelsesforhold henvises der til registreringsattesten)

Hvis dette anhængertræk monteres i henhold til vores anvisninger, vil det være til din fulde tilfredshed. Vi fralægger os ethvert ansvar ved ulovlig ændring eller brug af anhængertrækket.

DA

ΠΡΟΣΟΧΗ : (για να πληροφορηθείτε τα χαρακτηριστικά χρήσης συμβουλευτείτε την γκριζα κάρτα)

Εγκατεστημένο σύμφωνα με τις συστάσεις μας, αυτό το σύστημα ρυμούλκησης θα σας ικανοποιήσει πλήρως. Απεκδύομεθα πάσης ευθύνης σε περίπτωση μετατροπής ή παράνομης χρήσης αυτού.

EL

ATENCIÓN: (para conocer las características de utilización, consultar el permiso de circulación)

Instalado siguiendo nuestras recomendaciones, este enganche le dará total satisfacción. No asumiremos ninguna responsabilidad en caso de que haya sido transformado o utilizado ilícitamente.

ES

UWAGA (charakterystyki użytkowania należy sprawdzić w dowodzie rejestracyjnym)

Dyszel holowniczy będzie funkcjonował we właściwy sposób po zainstalowaniu go zgodnie z zaleceniami. Nie ponosimy żadnej odpowiedzialności w przypadku wprowadzenia zmian lub niedozwolonego użycia

PL

HUOMIO: (käyttöominaisuuksiin tutustumiseksi on katsottava rekisteriotetta)

Suosituksen mukaan asennettuna tämä vetokoukku täyttää odotuksesi.

Emme ota vastuuta, jos laitetta muutetaan tai käytetään ohjeiden vastaisesti.

FI

ATTENZIONE : (per conoscere le caratteristiche d'uso consultare il libretto di circolazione)

Installato seguendo le nostre raccomandazioni, questo gancio da traino vi lascerà completamente soddisfatti. Respingiamo ogni responsabilità in caso di trasformazione o utilizzo illecito dello stesso.

IT

LET OP : (voor gebruikskennmerken het kentekenbewijs raadplegen)

Indien u de koppeling volgens onze aanbevelingen heeft geïnstalleerd, zal het u tot volle tevredenheid stemmen. Wij stellen ons niet aansprakelijk in geval van wijziging of onrechtmatig gebruik.

NL

ADVARSEL: (for kunnskap om bruksegenskapene, se vognkortet)

Ved å installere innretningen i samsvar med våre anbefalinger vil du få maksimalt utbytte av dette tilhengerfestet. Vi fraskriver oss alt ansvar hvis tilhengerfestet endres eller brukes på ulovlig måte.

NO

POZOR: (užívateľské charakteristiky naleznete v technickém průkazu)

Tažné zařízení instalované dle našich doporučení vás plně uspokojí. V případě přestavby nebo neoprávněného užívání se zbavujeme veškeré odpovědnosti

CZ

VARNING: (Läs igenom registreringsbeviset för att ta reda på rådande användningsvillkor)

Om du monterar produkten enligt våra anvisningar kommer du uppnå bästa möjliga resultat. Vi avsäger oss allt ansvar i de fall kunden inte följt våra anvisningar fullt ut.

SV

FIGYELEM : (a használati jellegzetességeket a forgalmi engedélyből ismerheti meg)

A vonóhorog előírásainak megfelelő felszerelés esetén a terméket teljes elégedettséggel használhatja. A termék átalakítása vagy tiltott használata esetén semmilyen felelősséget nem vállalunk.

HU

ВНИМАНИЕ : (чтобы ознакомиться с рабочими характеристиками, изучите технический паспорт автомашины)

Установленное при соблюдении рекомендаций, данное тягово-сцепное устройство в полной мере удовлетворит ваши потребности. Производитель не несет никакой ответственности в случае деформации или

RU



siarr
WESTFALIA AUTOMOTIVE

304 159 (SI 221)

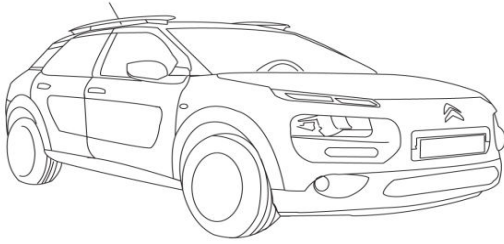

C4 CACTUS

Kg 1 630 kg



Kg 780 kg



Kg 55 kg

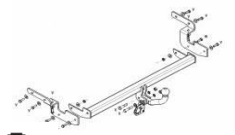

Kg 14,2 kg



5,18 kN



e24*55R-01*0355

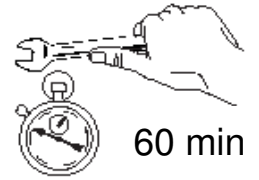

60 min

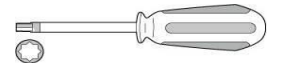
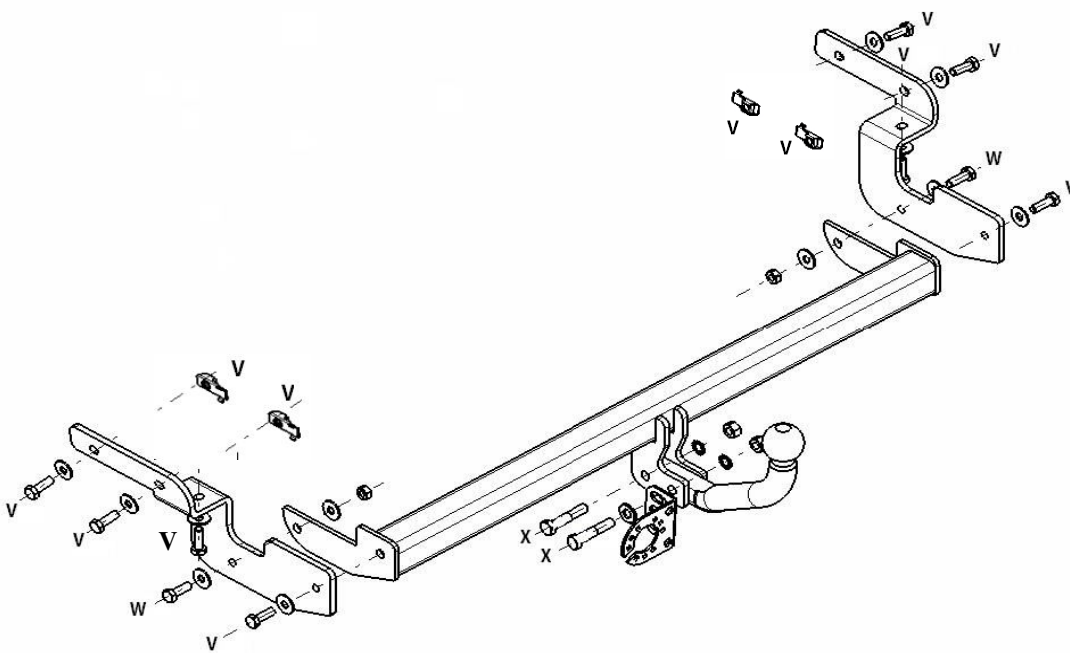

T25



17 - 19

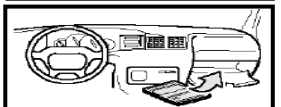
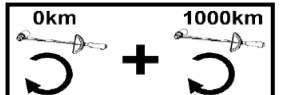
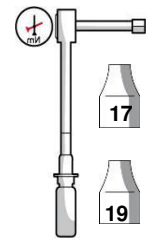

V		HM 10x30 cl 8,8	x 8
V		Ø10,5xØ27x2	x 8
V		M10	x 4
W		HM 10x30 cl 8,8	x 2
W		Ø10,5xØ27x2	x 4
W		M10 cl 8	x 2
X		HM 12x60 cl 8,8	x 2
X		DEC12	x 2
X		M12 cl 8	x 2

M12 AC 8,8
8,1daNm

M10 AC 8,8
4,7daNm

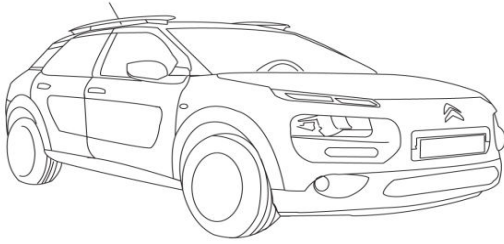

C4 CACTUS

Kg 1 630 kg



Kg 780 kg



Kg 55 kg



Kg 17,2 kg



5,18 kN



e24*55R-01*0356

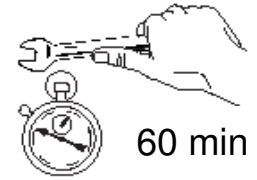

60 min

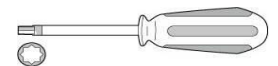
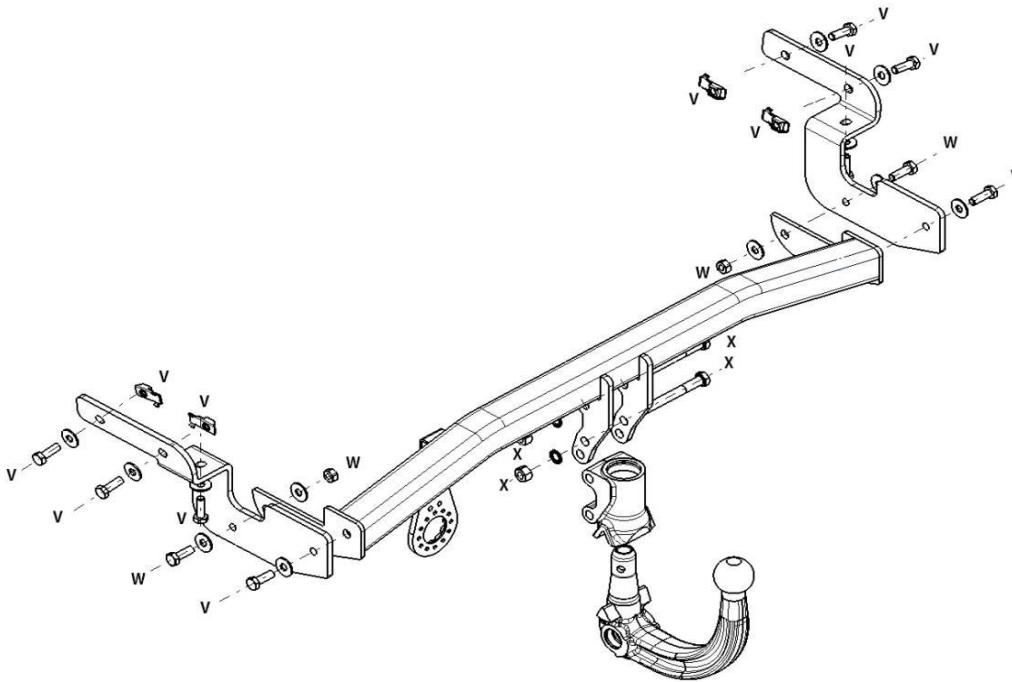

T25



17 - 19

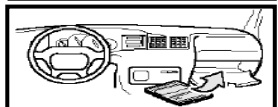
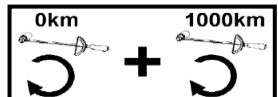
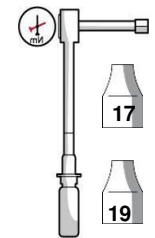

V		HM 10x30 cl 8,8	x 8
V		Ø10,5xØ27x2	x 8
V		M10	x 4
W		HM 10x30 cl 8,8	x 2
W		Ø10,5xØ27x2	x 4
W		M10 cl 8	x 2
X		HM 12x100 cl 10,9	x 2
X		DEC12	x 2
X		M12 cl 10	x 2

M12 AC 10,9
11,4daNm

M10 AC 8,8
4,7daNm

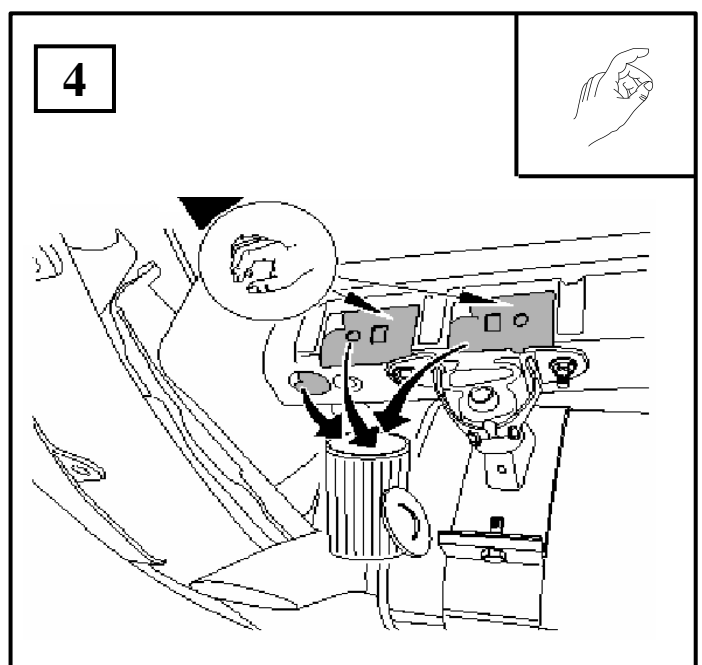
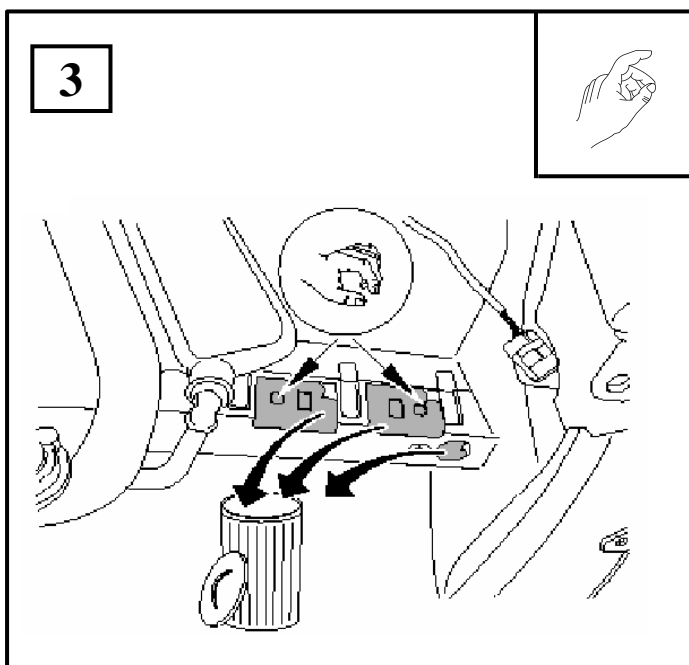
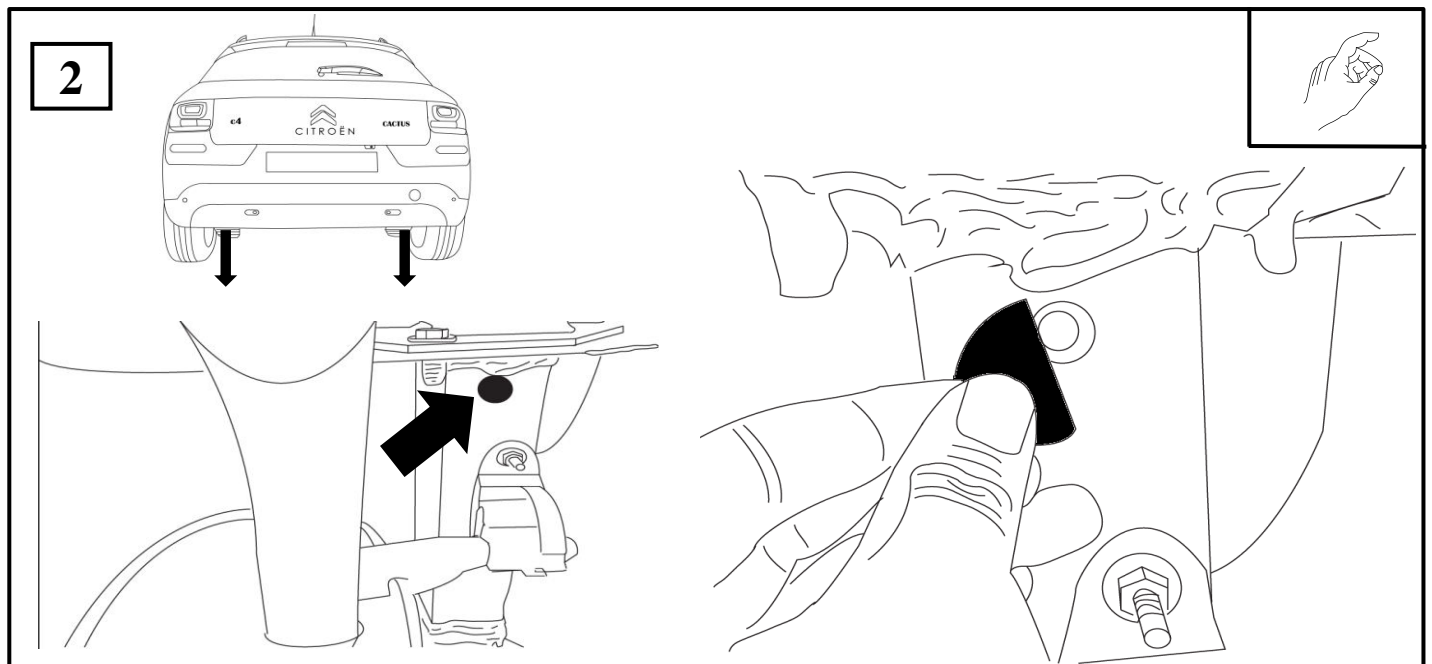
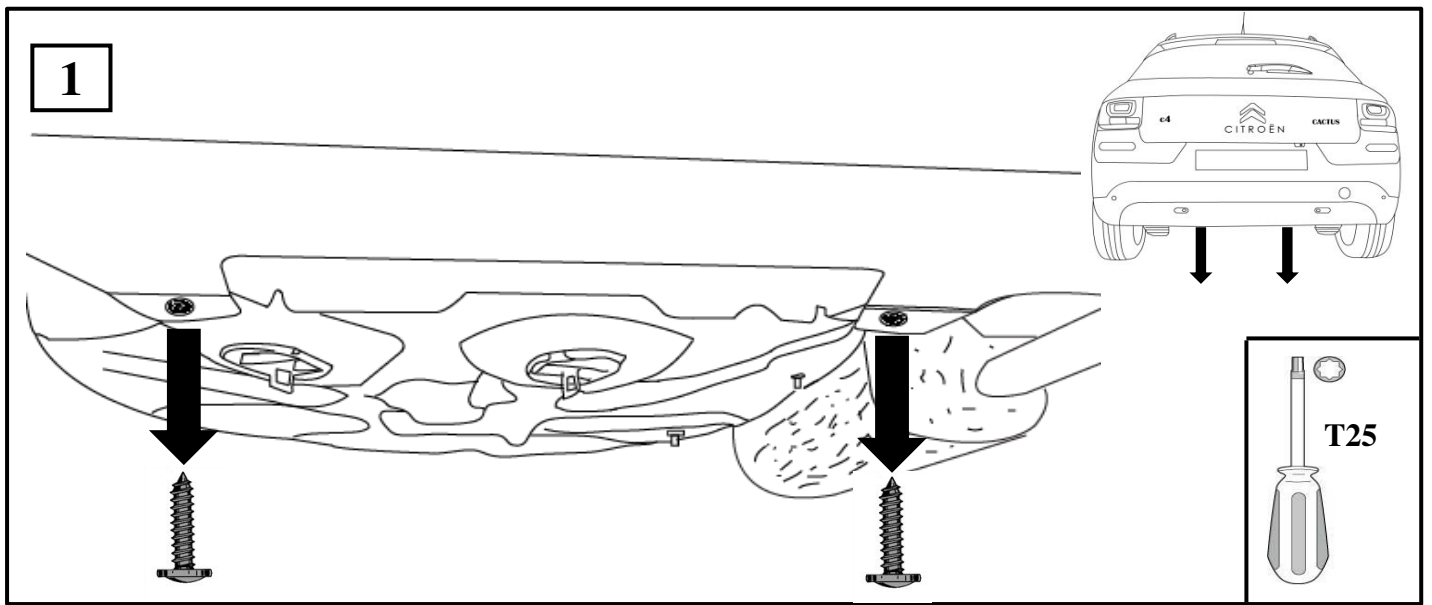

5

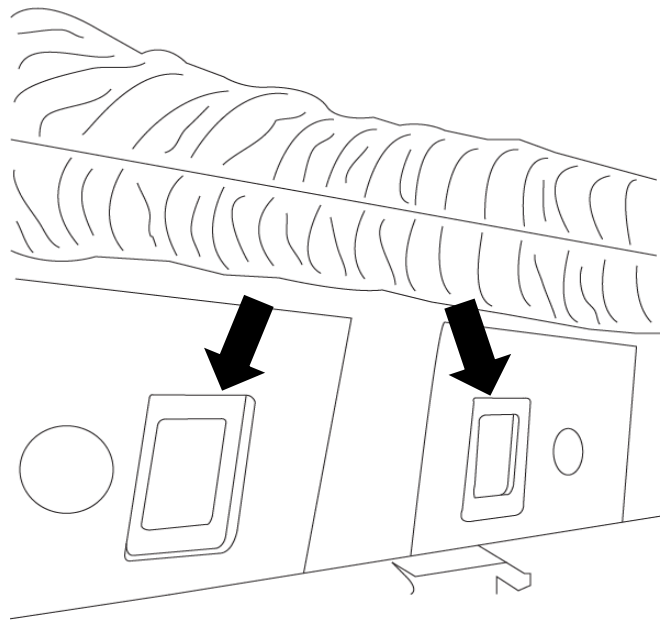
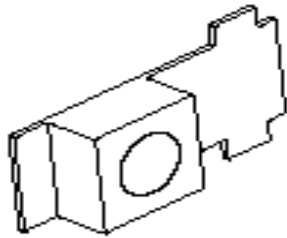
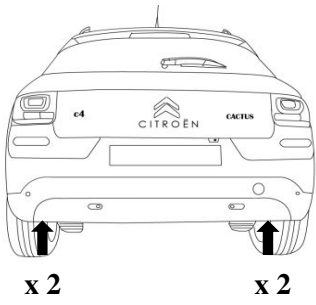

6

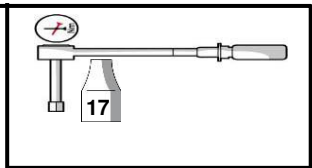
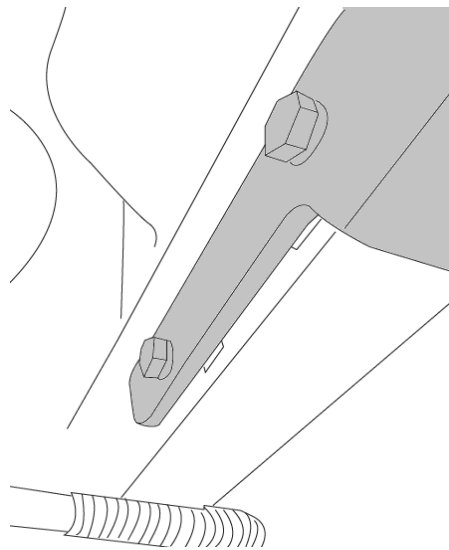
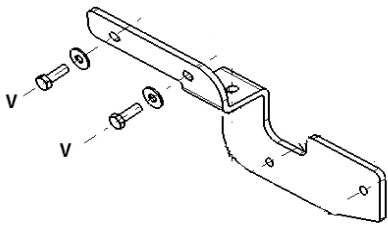
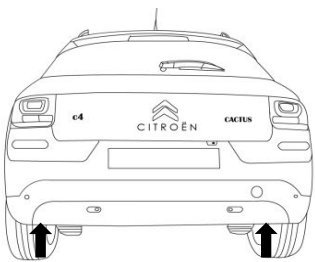

7

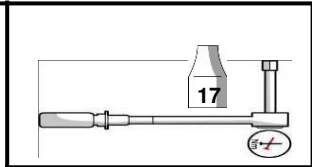
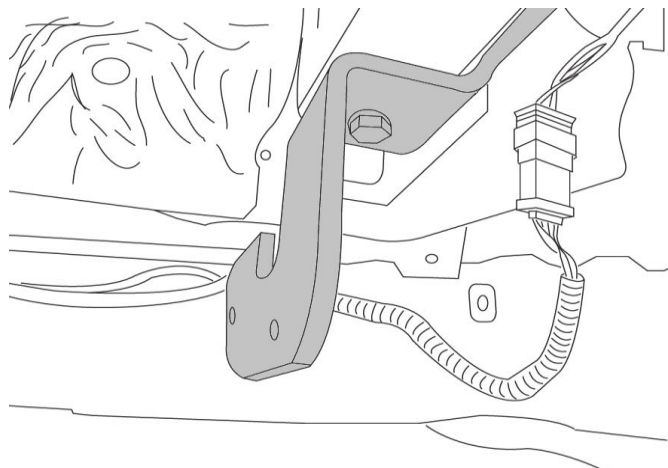
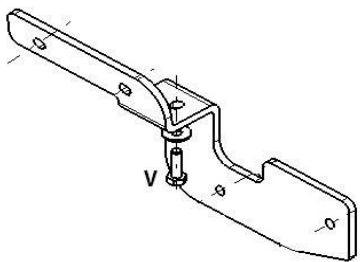
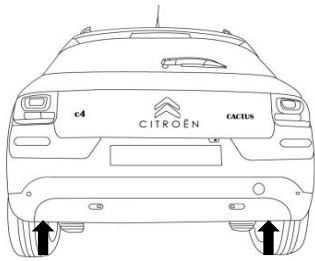

8

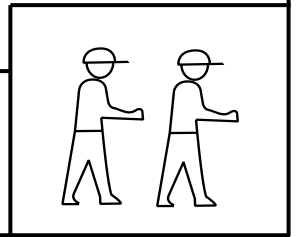
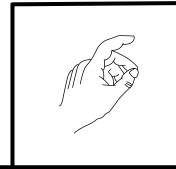
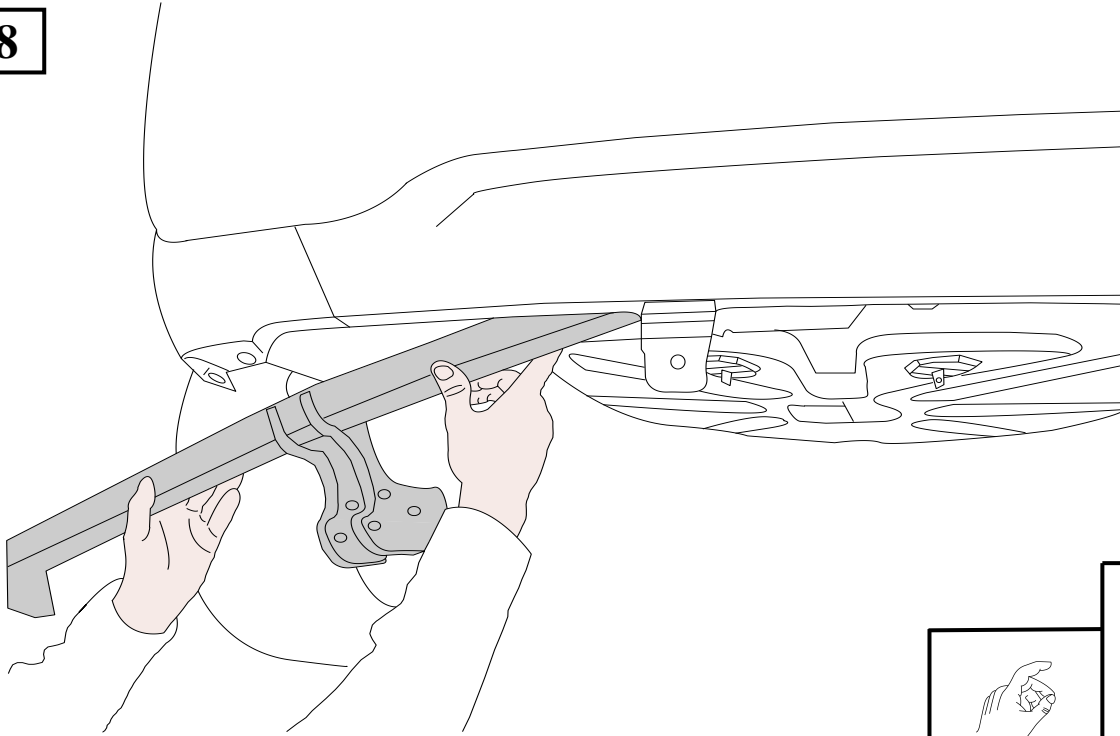

9

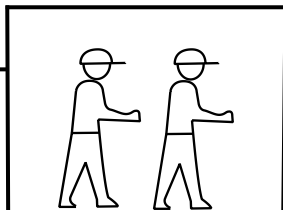
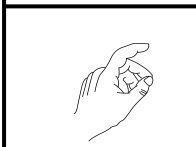
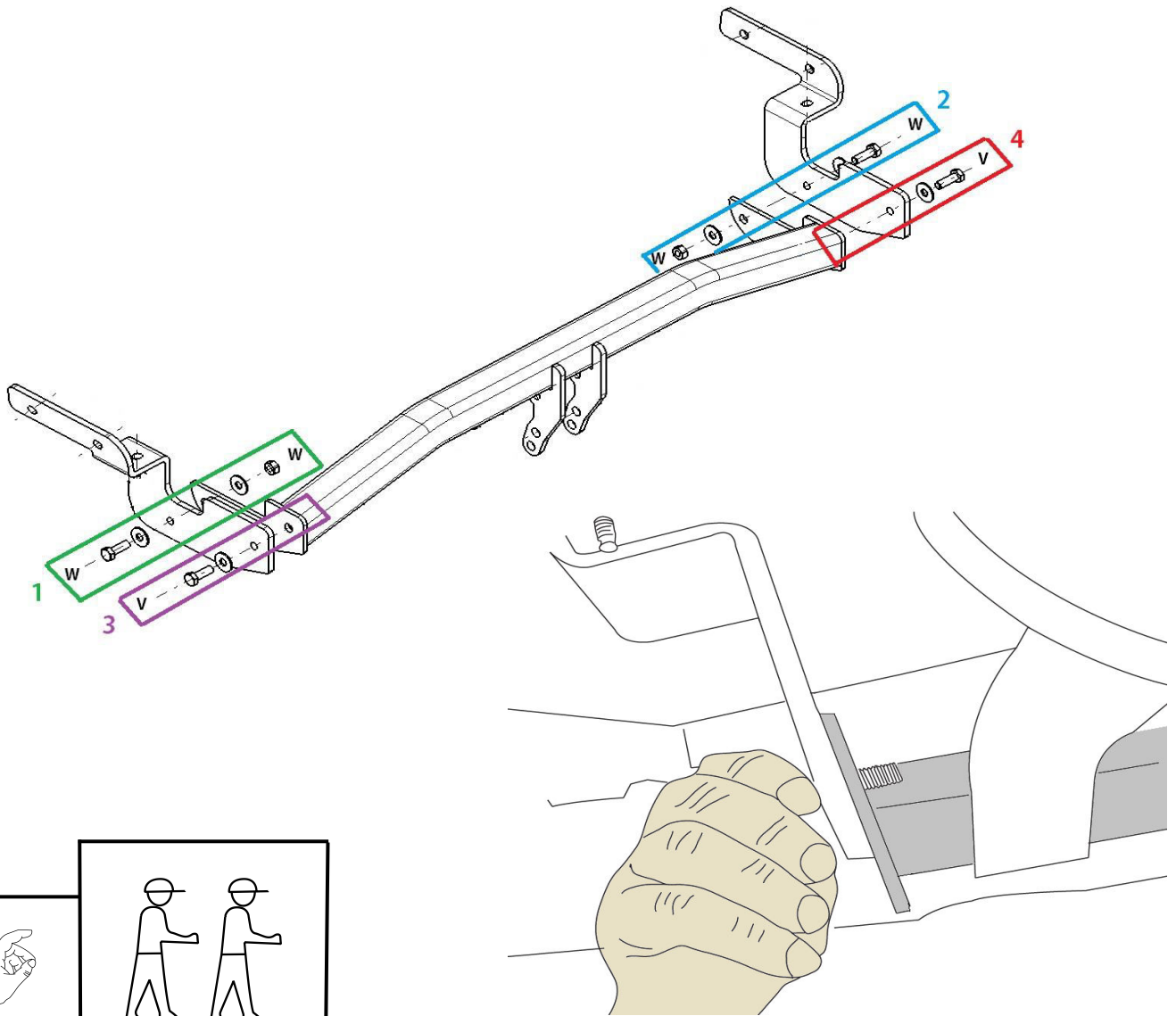

10

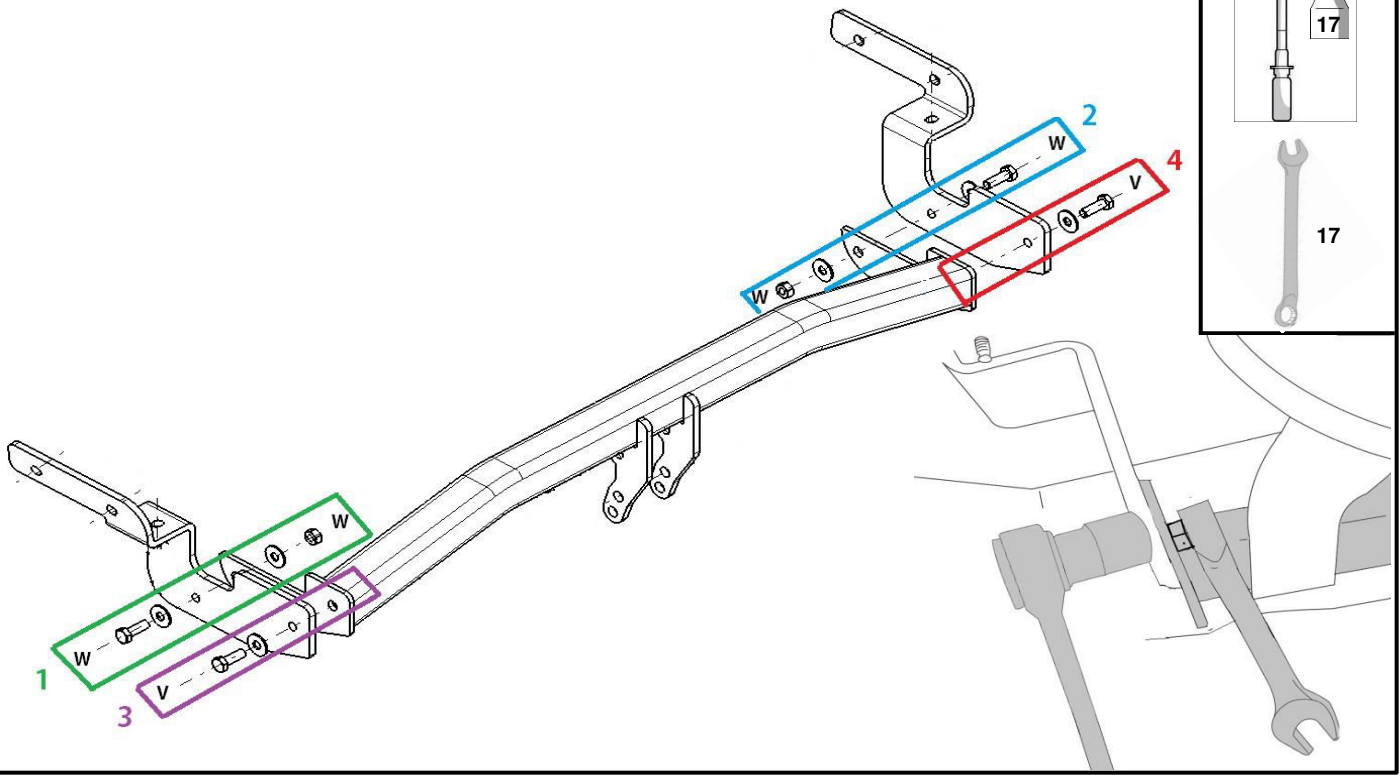

11



304 160

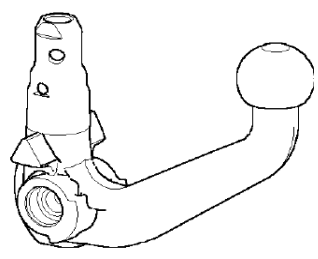

304 159

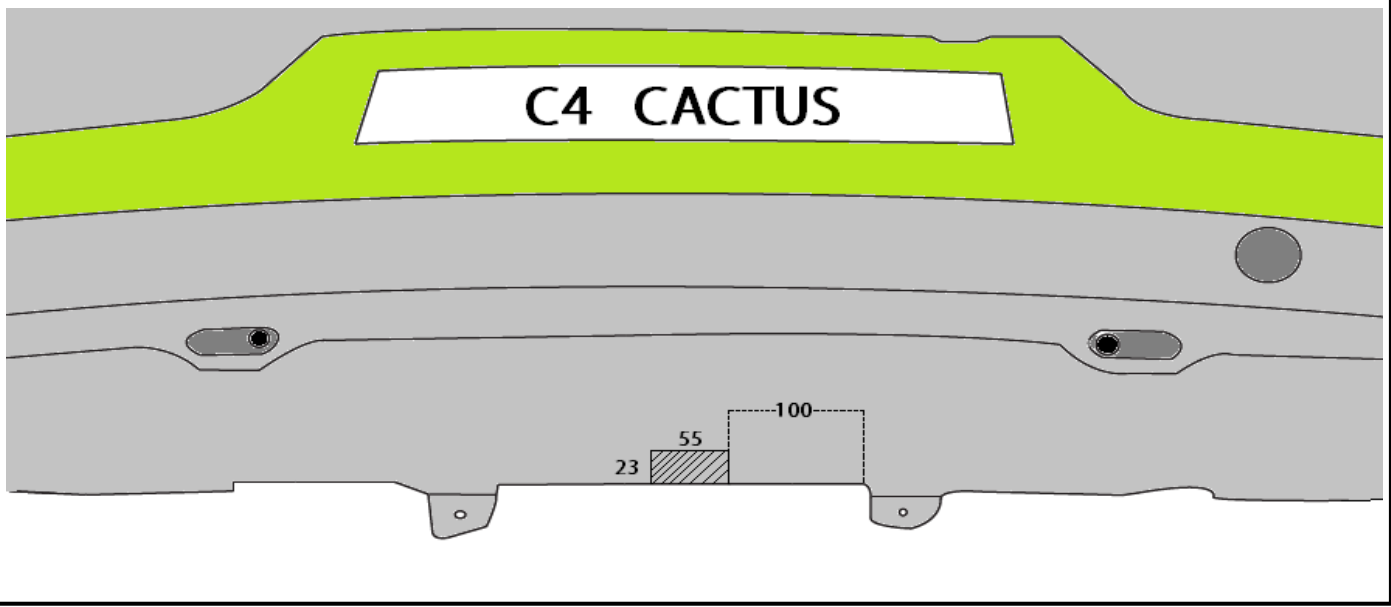
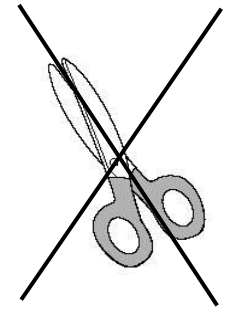
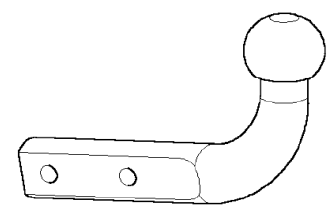

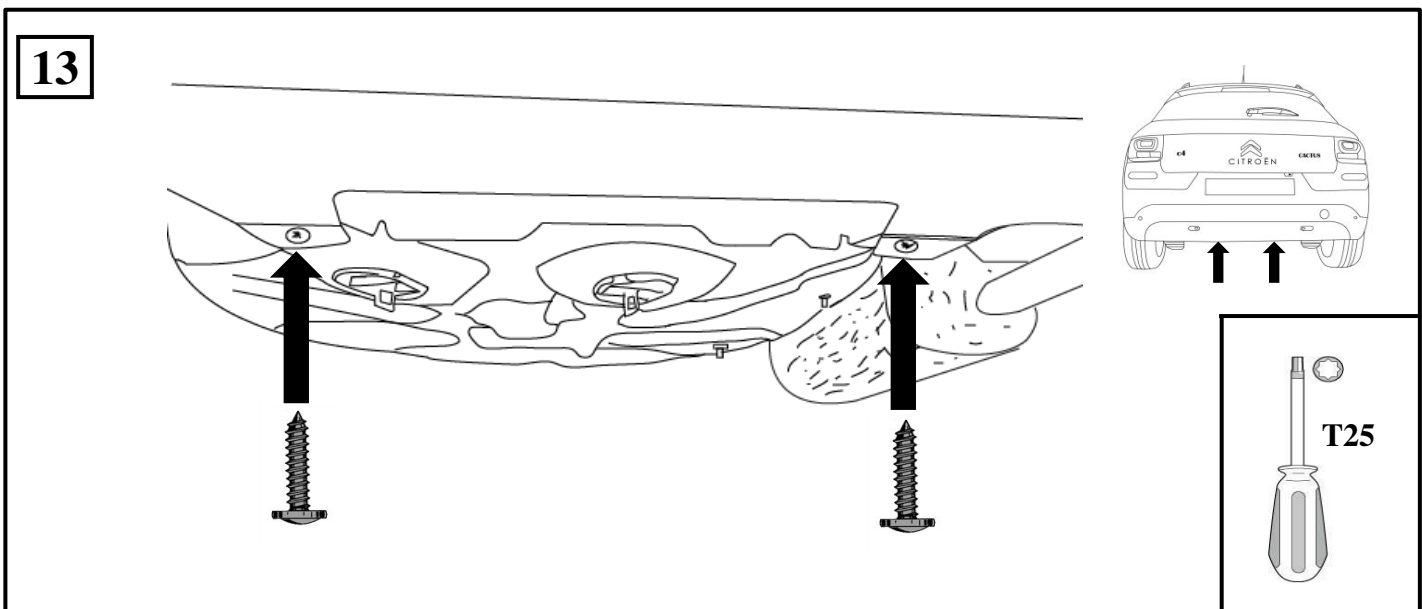
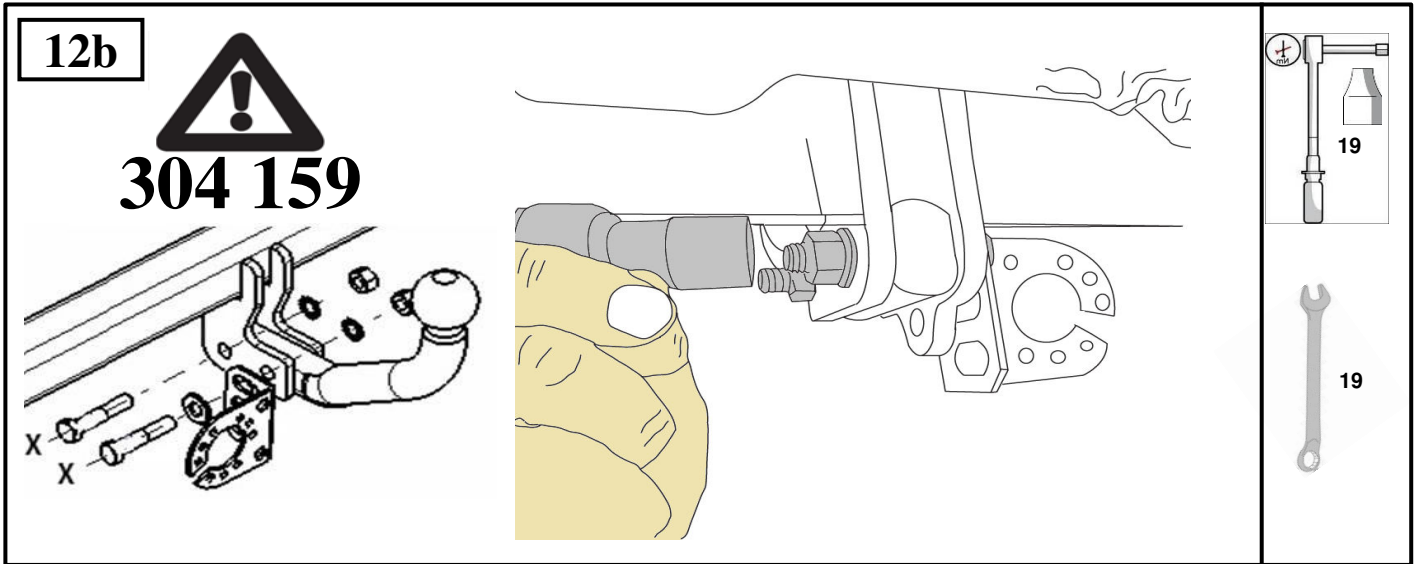
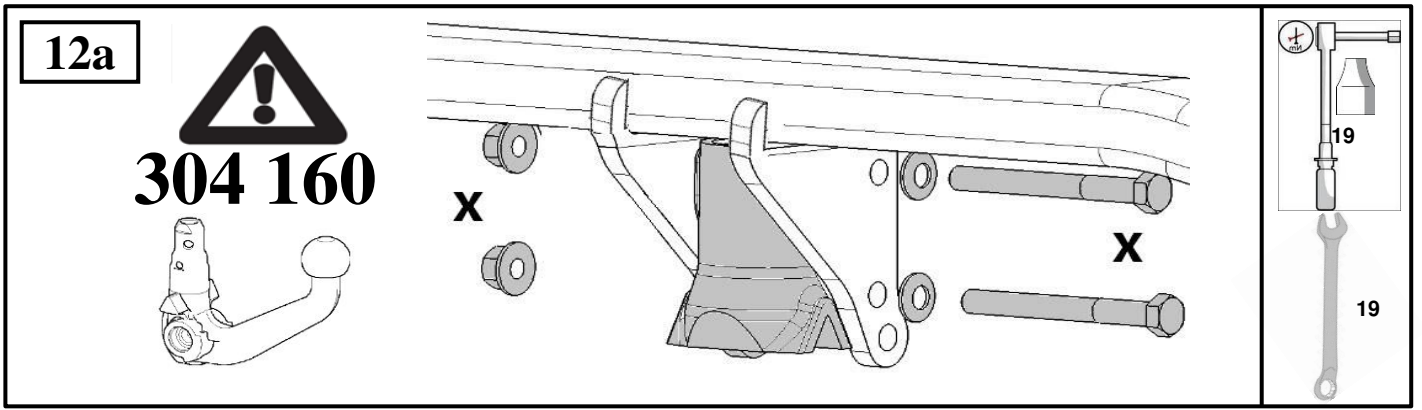

304159 / 304160

Indice A

22/09/2014

8 / 9

Dispositivo di traino tipo : **304159**
 Per autoveicolo : **Citroën C4 Cactus**
 Tipo funzionale : **0*****/*******



Classe e tipo di attacco : **A50-X**
 Omologazione : **e24*55R-01*0355**
 Valore D : **5,18 kN**
 Carico verticale max. S : **55 kg**
 Larghezza rimorchiabile per Caravan e T.A.T.S. : 2,45m vedere CARTA di CIRCOLAZIONE VEICOLO (motrice) + 70cm = ...arrotondare ai 5cm superiore (vedi D.M.28/05/85)
 Massa rimorchiabile : vedi carta di circolazione dell'autoveicolo

Per verificare l'idoneità del dispositivo di traino omologato a norma ECE-R55, all'installazione sulla vettura su cui si intende procedere al montaggio, compilare la seguente formula (se necessario declassare la massa rimorchiabile) :

$$D = \frac{T \times C}{T + C} \times 0,00981 < 5,18 \text{ kN}$$

dove : T = Massa Complessiva Max. della motrice (in kg)
 C = Massa Rimorchiabile Max. della motrice (in kg)

DA COMPILARE PER IL COLLAUDO

DICHIARAZIONE DI CORRETTO MONTAGGIO : la sottoscritta Ditta dichiara di aver montato in maniera corretta ed in conformità alle prescrizioni sia del costruttore del veicolo che del costruttore del dispositivo stesso il seguente dispositivo di attacco meccanico :

tipo :
 Il dispositivo di attacco sopra indicato è stato installato su autoveicolo
 modello :
 targa :
 Data :

TIMBRO e FIRMA

Si dichiara inoltre di aver informato l'utente del veicolo sull'USO e MANUTENZIONE del dispositivo stesso.

304159 / 304160

Indice A

22/09/2014

9 / 9

Dispositivo di traino tipo : **304160**
 Per autoveicolo : **Citroën C4 Cactus**
 Tipo funzionale : **0*****/*******



Classe e tipo di attacco : **A50-X**
 Omologazione : **e24*55R-01*0356**
 Valore D : **5,18 kN**
 Carico verticale max. S : **55 kg**
 Larghezza rimorchiabile per Caravan e T.A.T.S. : 2,45m vedere CARTA di CIRCOLAZIONE VEICOLO (motrice) + 70cm = ...arrotondare ai 5cm superiore (vedi D.M.28/05/85)
 Massa rimorchiabile : vedi carta di circolazione dell'autoveicolo

Per verificare l'idoneità del dispositivo di traino omologato a norma ECE-R55, all'installazione sulla vettura su cui si intende procedere al montaggio, compilare la seguente formula (se necessario declassare la massa rimorchiabile) :

$$D = \frac{T \times C}{T + C} \times 0,00981 < 5,18 \text{ kN}$$

dove : T = Massa Complessiva Max. della motrice (in kg)
 C = Massa Rimorchiabile Max. della motrice (in kg)

DA COMPILARE PER IL COLLAUDO

DICHIARAZIONE DI CORRETTO MONTAGGIO : la sottoscritta Ditta dichiara di aver montato in maniera corretta ed in conformità alle prescrizioni sia del costruttore del veicolo che del costruttore del dispositivo stesso il seguente dispositivo di attacco meccanico :

tipo :
 Il dispositivo di attacco sopra indicato è stato installato su autoveicolo
 modello :
 targa :
 Data :

TIMBRO e FIRMA

Si dichiara inoltre di aver informato l'utente del veicolo sull'USO e MANUTENZIONE del dispositivo stesso.