

Chrysler Grand Cherokee 2005-

Partnr.: CR-027-HH

DE	Einbauanleitung Elektrosatz Anhängervorrichtung mit 13-P Steckdose lt. DIN/ISO Norm 11446	CZ	Montážní pokyny: souprava pro elektrické propojení tažné tyče s 13-P zásuvkou do normy DIN/ISO 11446.
FR	Instructions de montage du faisceau électrique pour crochet d'attelage conforme à la norme DIN/ISO 11446 prise 13-V.	DK	Monteringsvejledninger for det elektriske ledningsføringssæt for trækstang med 13-N stikdåse, DIN/ISO, norm 11446.
NL	Montage-handleiding elektrokabelset voor trekhaak met 13-P contactdoos vlg. DIN/ISO norm 11446.	FI	Ohjeet vetokoukun sähkökaapelisarjan asentamiseen, jossa on DIN/ISO 11446 mukainen 13-N liitin.
GB	Fitting instructions electric wiring kit tow bar with 13-P socket up to DIN/ISO Norm 11446.	GR	Οδηγίες συναρμολόγησης ηλεκτρικού σετ καλωδίων μπάρας ρυμούλκησης με υποδοχή 13-P μέχρι DIN/ISO Κανόνας 11446.
ES	Instrucciones de montaje de kit eléctrico para enganche de remolque con caja de conexiones 13-P según norma DIN/ISO 11446.	NO	Monteringsanviser elkabelsett for trekkrok med 13-P koblingsboks ifølge DIN/ISO norm 11446.
IT	Istruzioni di montaggio di set di cavi elettrici per gancio da traino con zoccolo a 13-P conforme alla norma DIN/ISO 11446.	PL	Instrukcje montażu zestawu okablowania elektrycznego dysza holowniczego z 13-stykowym gniazdem DIN/ISO 11446.
SE	Monteringsanvisningar elkabelsats för dragkrok med 13-P kontaktdosa enligt DIN/ISO norm 11446.		

DE	- Wir weisen ausdrücklich darauf hin, dass eine unsachgemäße und nicht in einer Fachwerkstatt durchgeführte Montage einen Verzicht auf Entschädigung jeglicher Art insbesondere bezüglich des Produkthaftpflichtrechts zur Folge hat	- Technische Änderungen vorbehalten.	- Widerstand nur gemäß der Tabelle auf dem Anhänger verwenden, siehe Seite 12.
FR	- Il est expressément prévu qu' on ne saurait se prévaloir d'un quelconque préjudice contractuel ou rédhitoire si le montage avait été fait en dépit des dites instructions ou dans un garage ne disposant pas des équipements adéquats.	- Sous réserve de modifications techniques.	- Ne excédez pas la charge maximale, indiquée dans le tableau sur page 12.
NL	- Wij wijzen er met nadruk op, dat ondeskundige en niet door een vakkundige werkplaats uitgevoerde montage tot gevolg heeft dat daardoor ieder recht op schadevergoeding, ook op wettelijke aansprakelijkheid inzake producten, vervalt.	- Technische wijzigingen voorbehouden.	- Gebruik alleen belasting volgens aansluittabel op het getrokken voertuig, zie pagina 12.
GB	- We would expressly point out that assembly not carried out properly by a competent installer will result in cancellation of any right to damage compensation, in particular those arising by virtue of the product liability act.	- Contents of these kits and their fitting manuals are subject to alteration without notice, please ensure that these instructions are read and fully understood before commencing installation.	- Do not overload circuits; the maximum loads per connection are detailed in this manual.
ES	- El montaje inapropiado y efectuado por personal no cualificado originará la pérdida de todo derecho a indemnización o la expiración de toda responsabilidad civil con respecto al producto.	- Nos reservamos el derecho a efectuar modificaciones técnicas.	- Utilice sólo cargas de acuerdo a la tabla de conexión del vehículo remolcado (ver página 12).
IT	- Sottolineiamo espressamente che un montaggio inadeguato ed eseguito da un'officina non specializzata ha come conseguenza il decadere di qualsiasi diritto al risarcimento danni, nonché alla responsabilità legale relativa ai prodotti.	- Ci si riserva il diritto di apportare modifiche tecniche.	- Utilizzare esclusivamente un carico conforme alla tabella degli allacci relativa al veicolo in questione, cfr. pagina 12.
SE	- Vi påpekar med eftertryck att all rätt till skadeersättning och all laglig ansvarighet förfaller om monteringen inte har utförts på rätt sätt och av en professionell verkstad.	- Tekniska ändringar förbehålles.	- Använd endast belastning enligt anslutningstabellen på det dragna fordonet, se sid. 12.
CZ	- Výslovně zdůrazňujeme, že jakákoli montáž, která není provedena ve specializované dílně, má za následek odvolání nároku na kompenzaci jakéhokoli druhu, obzvláště vyplývajících ze zákona o odpovědnosti za způsobené škody.	- Změny mohou být provedeny bez oznámení.	- Používejte pouze při maximálním nabití podle tabulky na tažném vozidle, viz. str. 12.
DK	- Vi ønsker at gøre udtrykkeligt opmærksom på at forkert samling, der ikke er udført af et specialiseret værksted, resulterer i bortfaldelse af kompensationskrav af alle slags, i særdeles krav der måtte opstå omkring det lovpligtige ansvar.	- Kan ændres uden varsel.	- Brug kun den maksimale belastning, i overensstemmelse med forbindelsstabellen for busserede køretøjer, side 12.
FI	- Korostamme, että kaikki oikeudet vahinkokorvaukseen kuten myös valmistajan laillinen vastuu raukeavat, mikäli asennusta ei ole toteutettu oikealla tavalla eikä ammattitaitoisien asiantuntijain toimesta.	- Oikeus teknisiin muutoksiin ilman erillistä huomautusta pidätetään.	- Kuormita työvirtapiliiriä ainoastaan hinnattavan ajoneuvon kytkentäkaavion mukaisesti, katso sivu 12.
GR	- Επισημαίνουμε κατηγορηματικά ότι οποιαδήποτε εσφαλμένη συναρμολόγηση, η οποία δεν έχει πραγματοποιηθεί ειδικό εργαστήριο θα οδηγήσει σε αποποίηση των αξιώσεων επιβολής αποζημιώσεων οποιαδήποτε είδους, ειδικά όσα προκύπτουν από το νόμο ευθύνης προϊόντων.	- Μπορεί να τροποποιηθεί χωρίς προηγούμενη ειδοποίηση.	- Χρησιμοποιείτε μόνο μέγιστο ηλεκτρικό φορτίο σύμφωνα με τον πίνακα σύνδεσης στο ρυμούλκούμενο όχημα, δείτε σελίδα 12.
NO	- Vi påpeker ettertrykkelig at all rett til skadeerstatning og rettslig ansvar forfaller dersom monteringen ikke er blitt utført på riktig måte og av et profesjonelt verksted.	- Tekniske endringer forbeholdes.	- Overskrid ikke grensene anviset i tilkoblingstabellen på tilhengeren eller det tilkoblede kjøretøyet, se s. 12.
PL	- Chcielibyśmy wyraźnie zaznaczyć, iż wszelki nieprawidłowy montaż, który nie jest wykonywany w specjalistycznym warsztacie pociąga za sobą utratę możliwości dochodzenia wszelkiego typu roszczeń, w szczególności tych wynikających z odpowiedzialności producenta za swój produkt.	- Podlega zmianom bez powiadomienia.	- Używać tylko takiego maksymalnego obciążenia które wynika z tabliczki połączeń holowanego pojazdu, patrz strona 12.

342 097300.113

Einzelteilliste

Liste de pieces

Onderdelenlijst

Part list

Lista de componentes

Elenco componenti

Dellista

Seznam dílů

Del-liste

Osaluettelo

Κατάλογος εξαρτημάτων

Delliste

Lista części

DE

FR

NL

GB

ES

IT

SE

CZ

DK

FI

GR

NO

PL

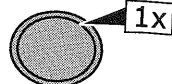
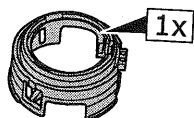
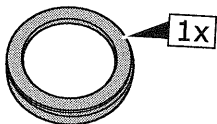
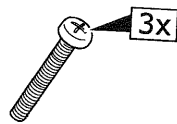
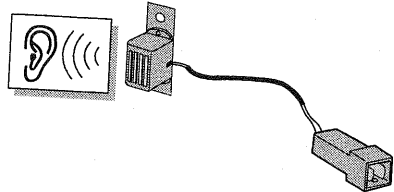
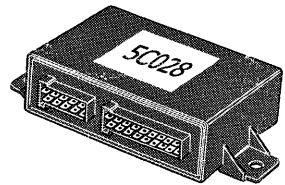
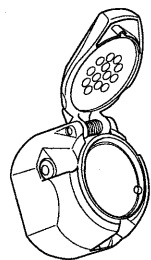
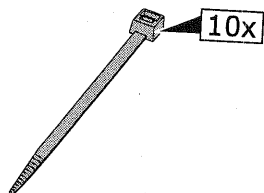
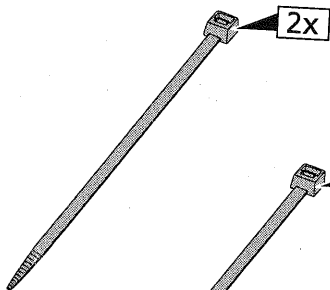
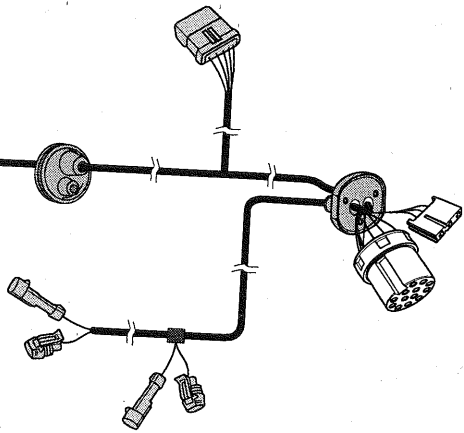
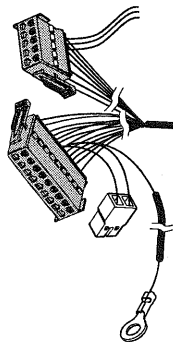
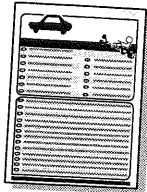
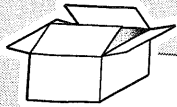

1

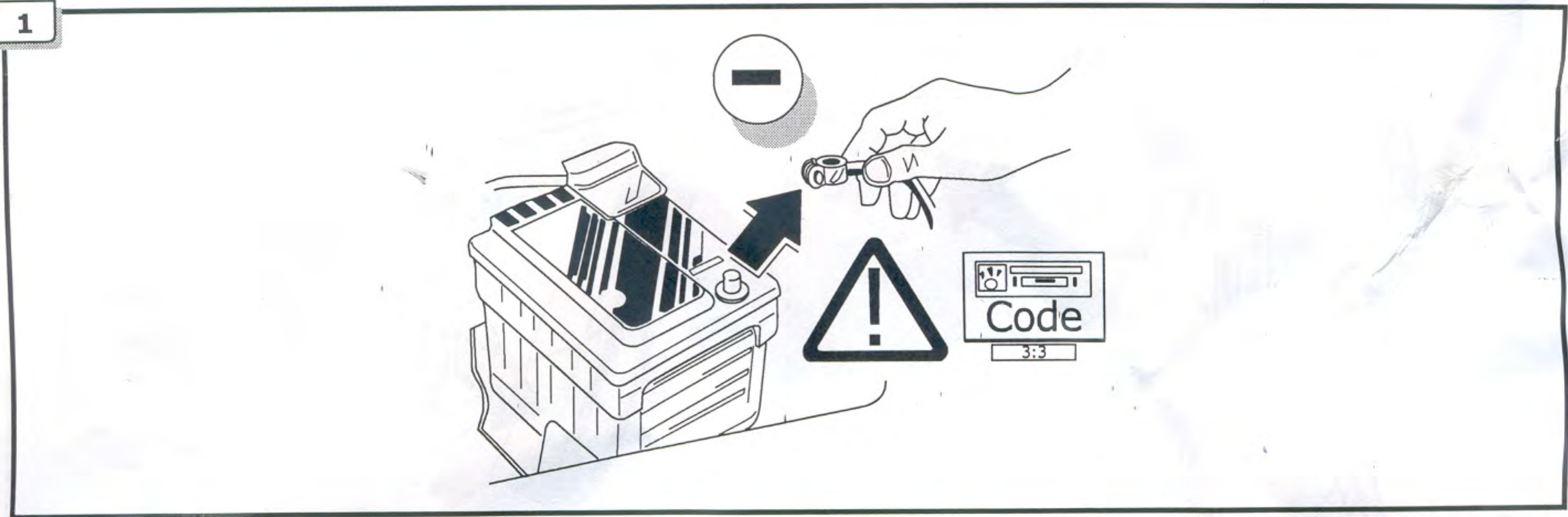

2

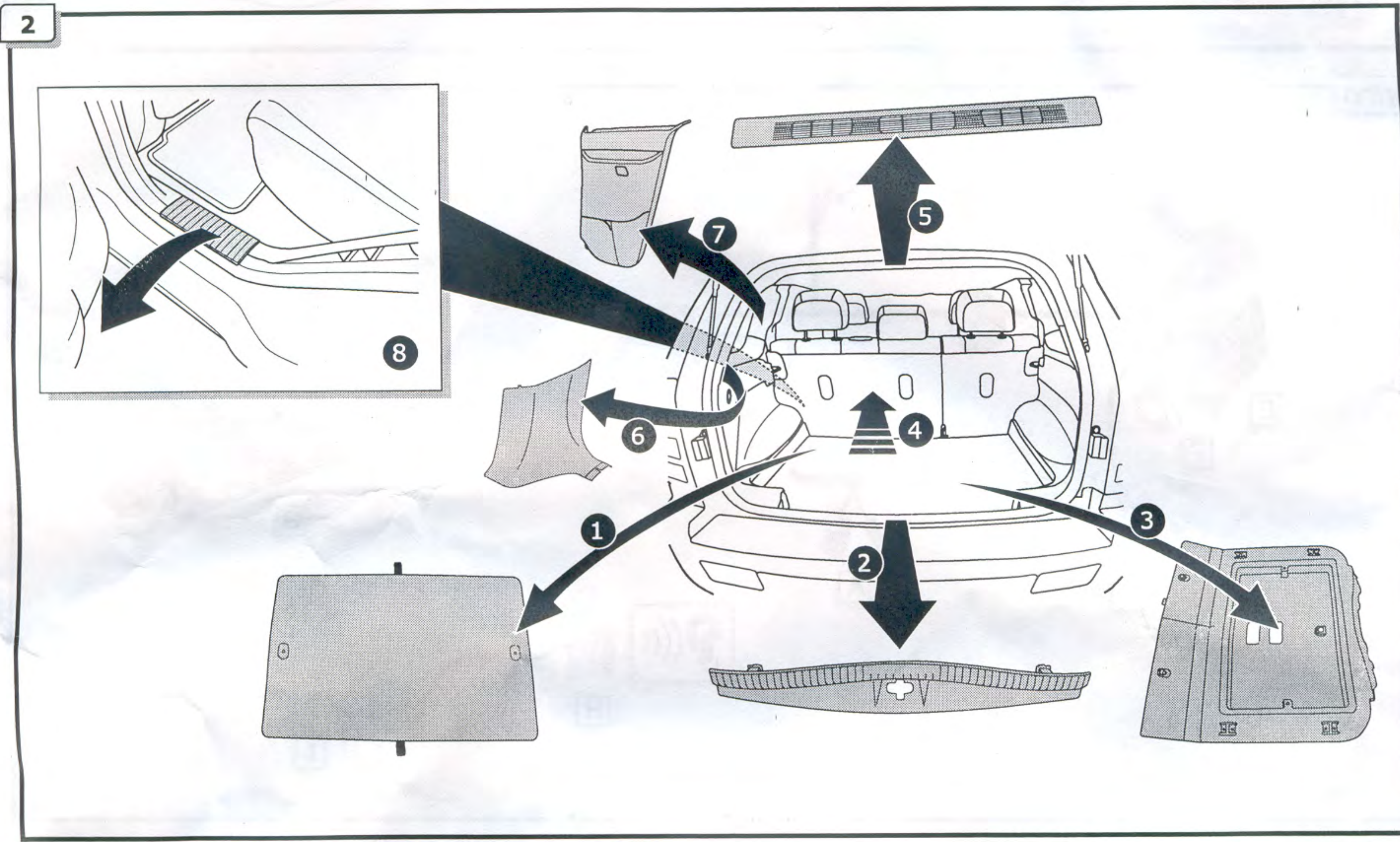

3

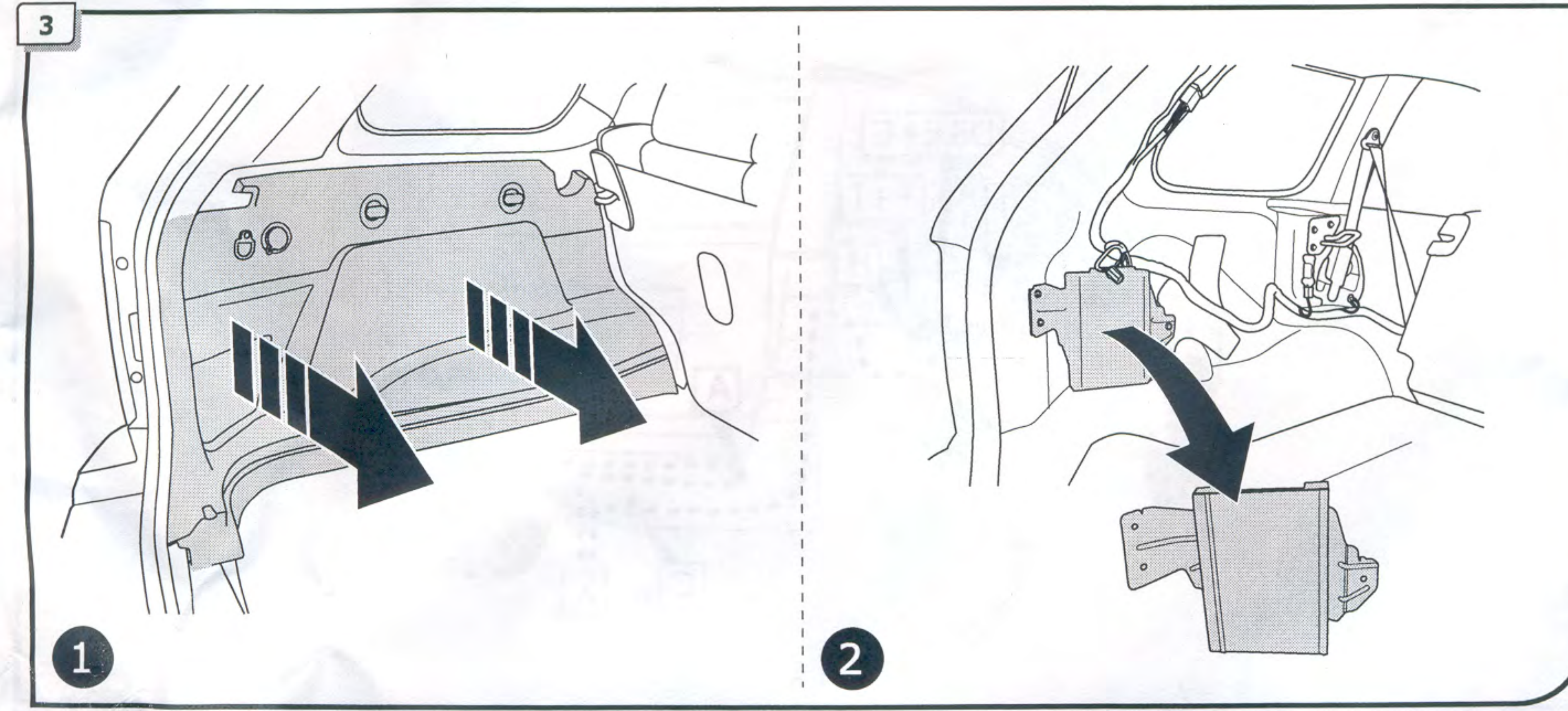

4

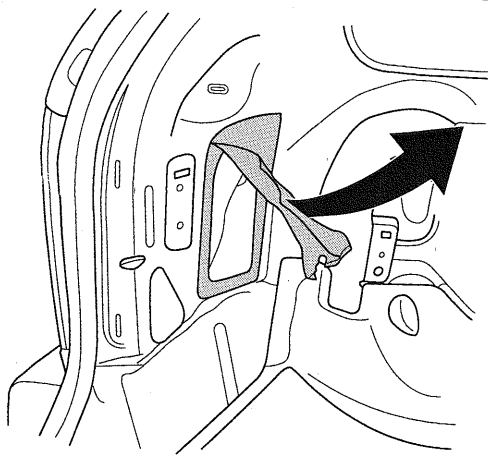

1

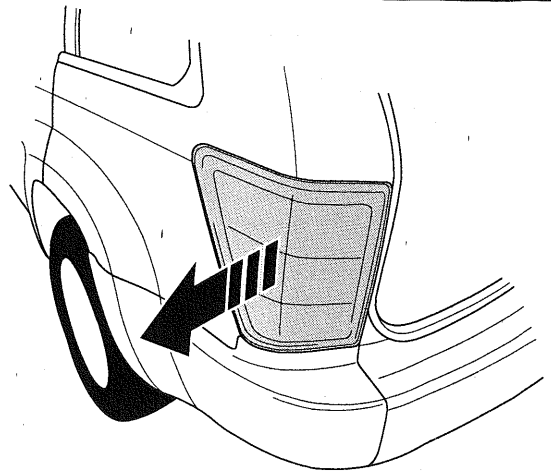

2

INFO

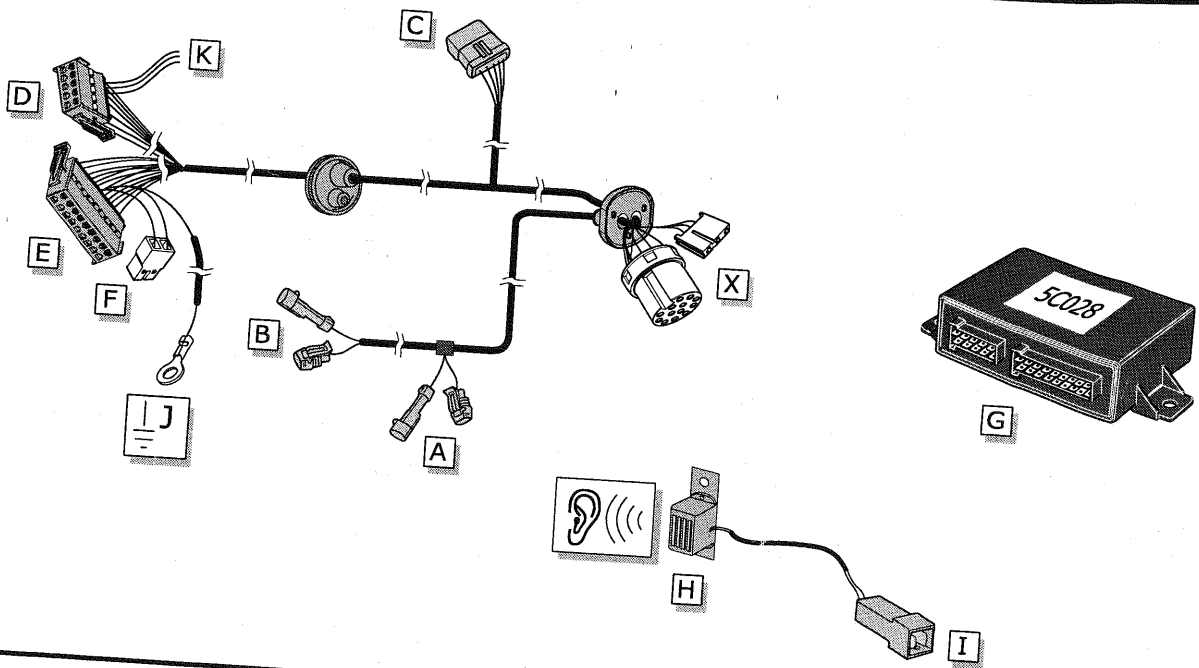

ROUTING

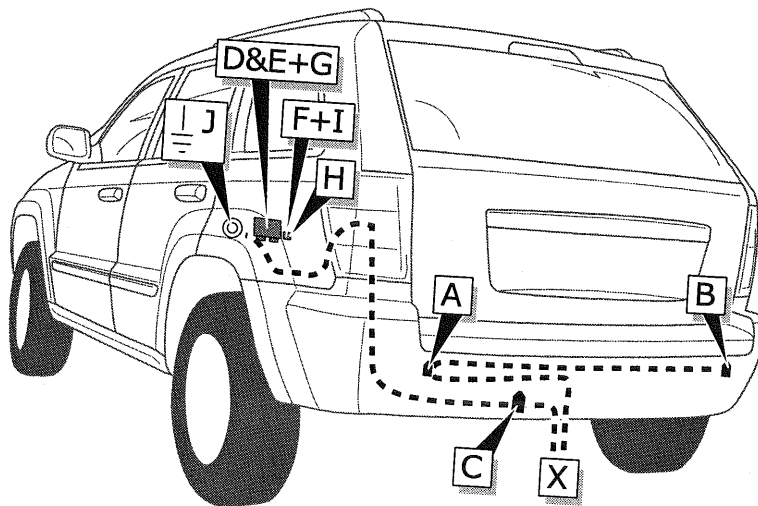

5

105 mm

225 mm

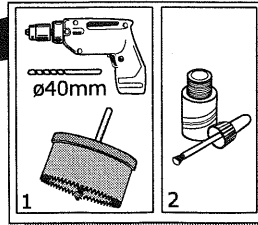

6

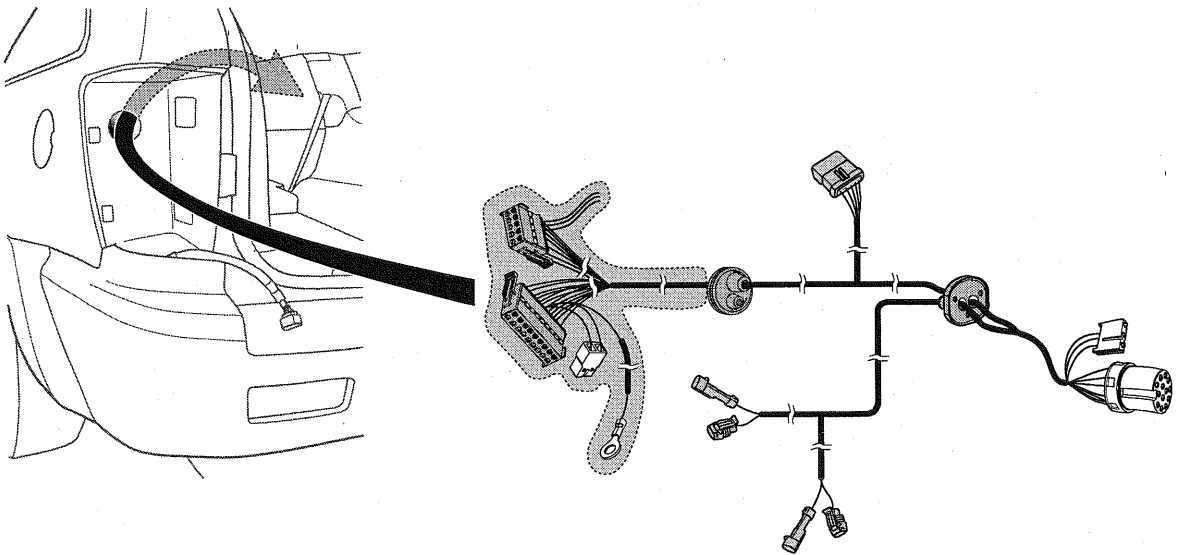

7

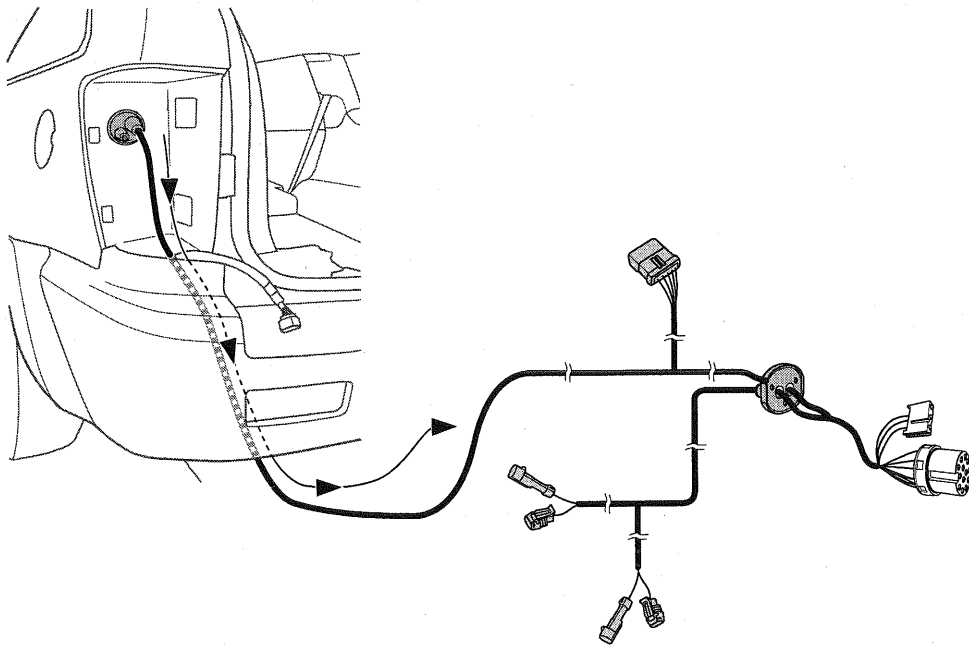

INFO

- ⓓⓔ Option
- ⓕⓡ Option
- ⓃⓁ Optie
- ⓖⓔ Option
- ⓔⓢ Opción
- ⓙⓣ Opzione
- Ⓢⓔ Tillval
- ⓐⓏ Varianta
- ⓓⓀ Ekstraudstyr
- ⓕⓙ Vaihtoehto
- ⓖⓡ Επιλογή
- Ⓝⓞ Eventuelt
- ⓔⓁ Opcja

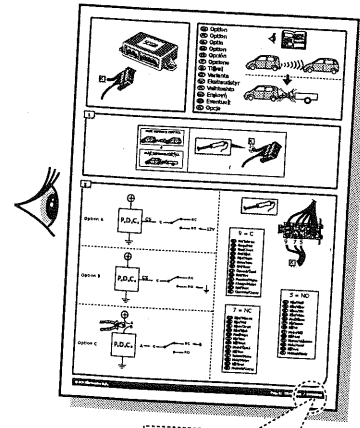
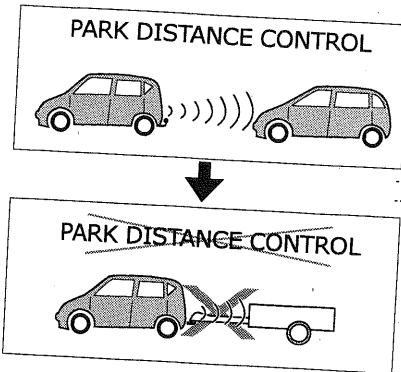

Pag. 11

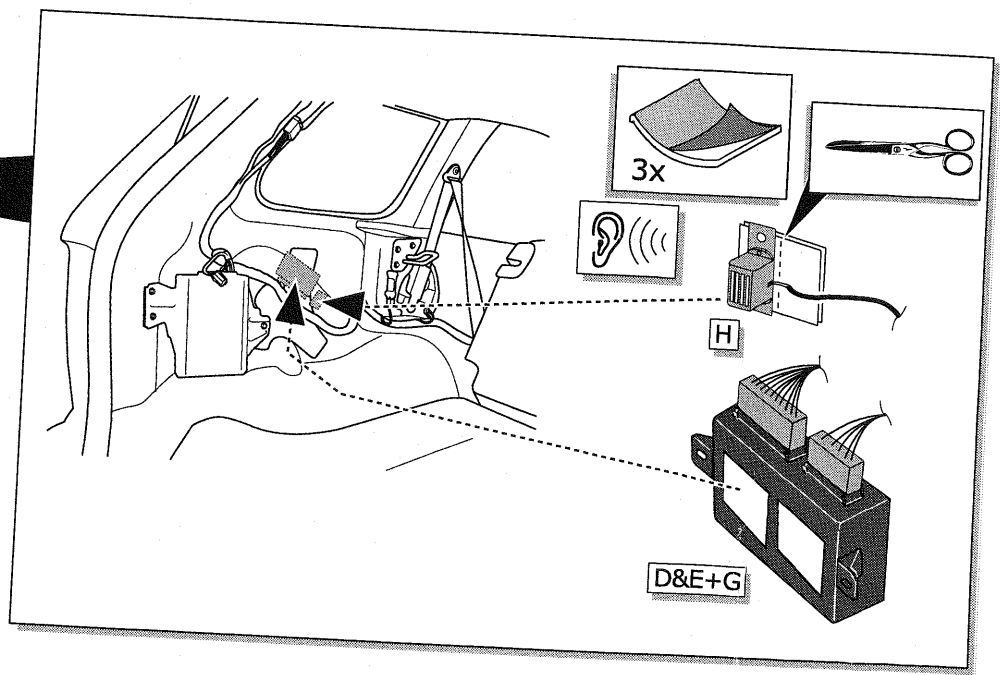
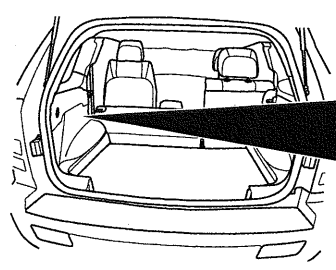
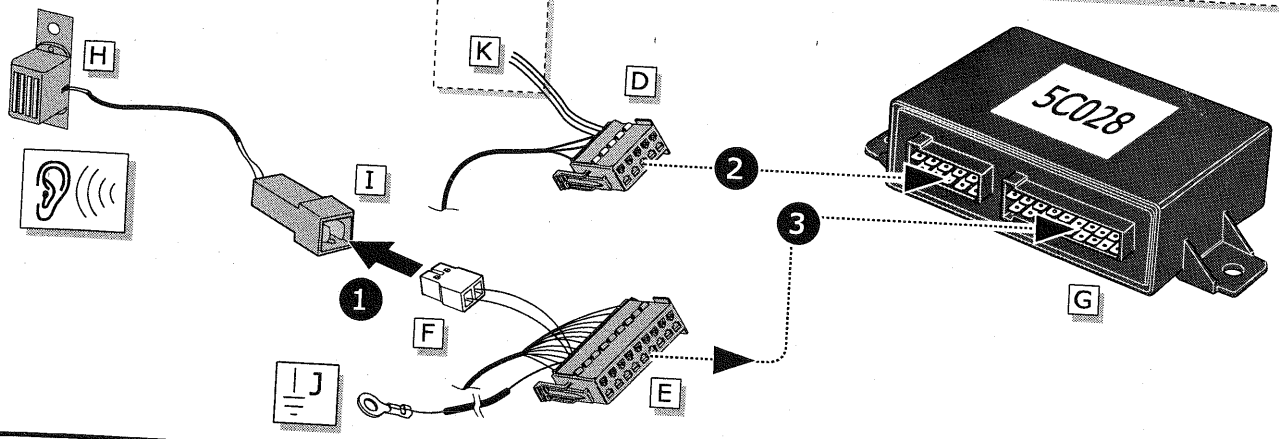

10

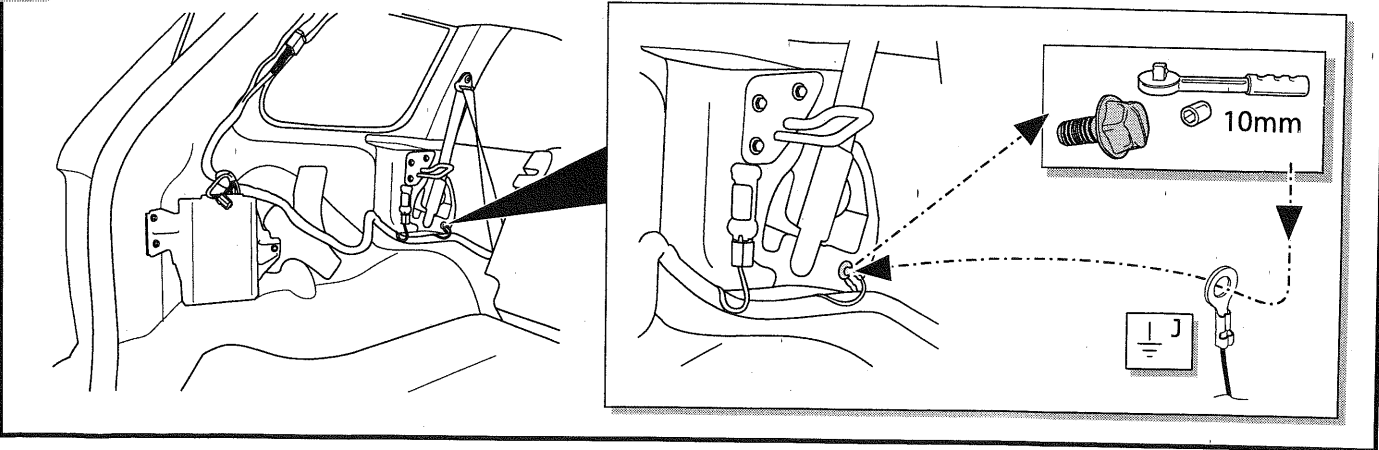

11

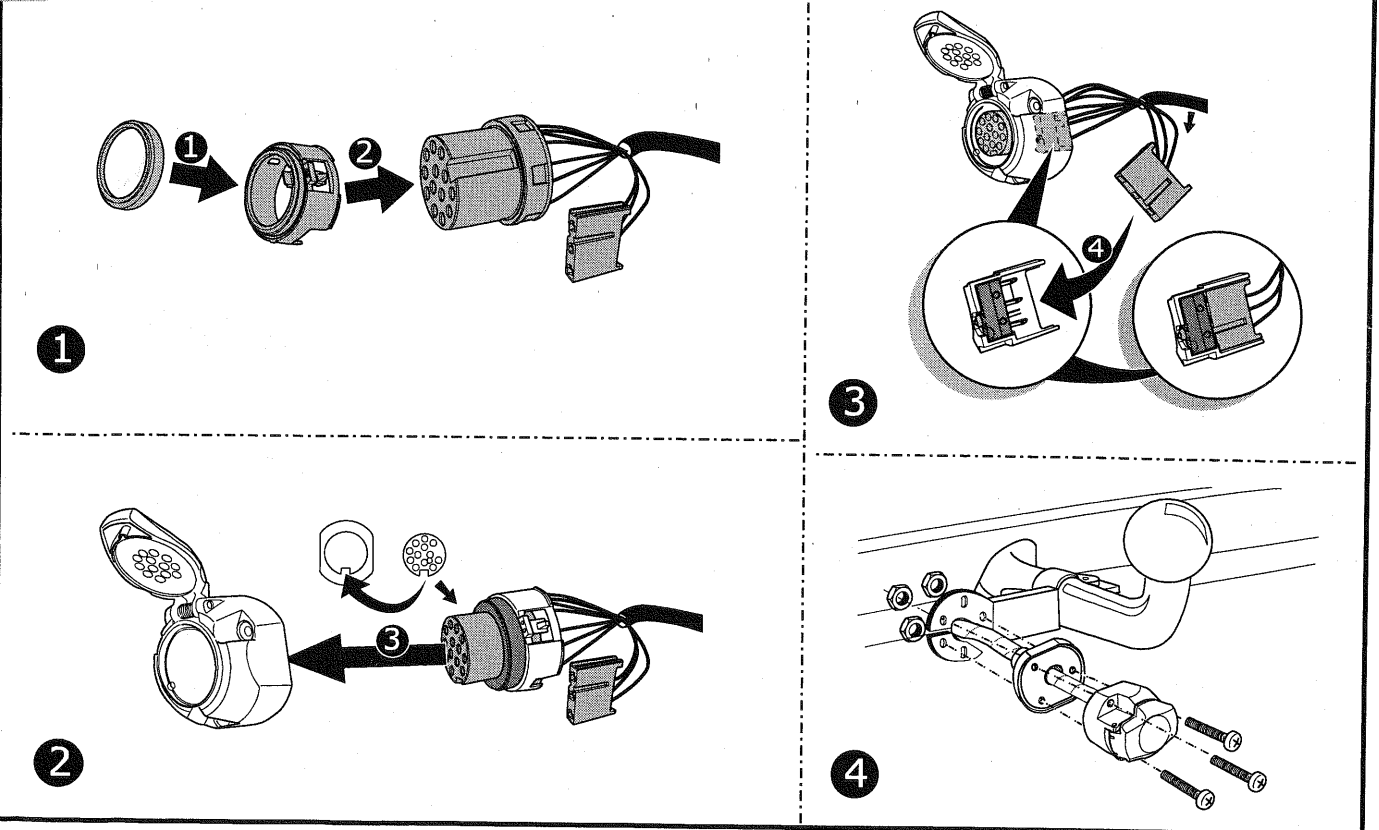

12

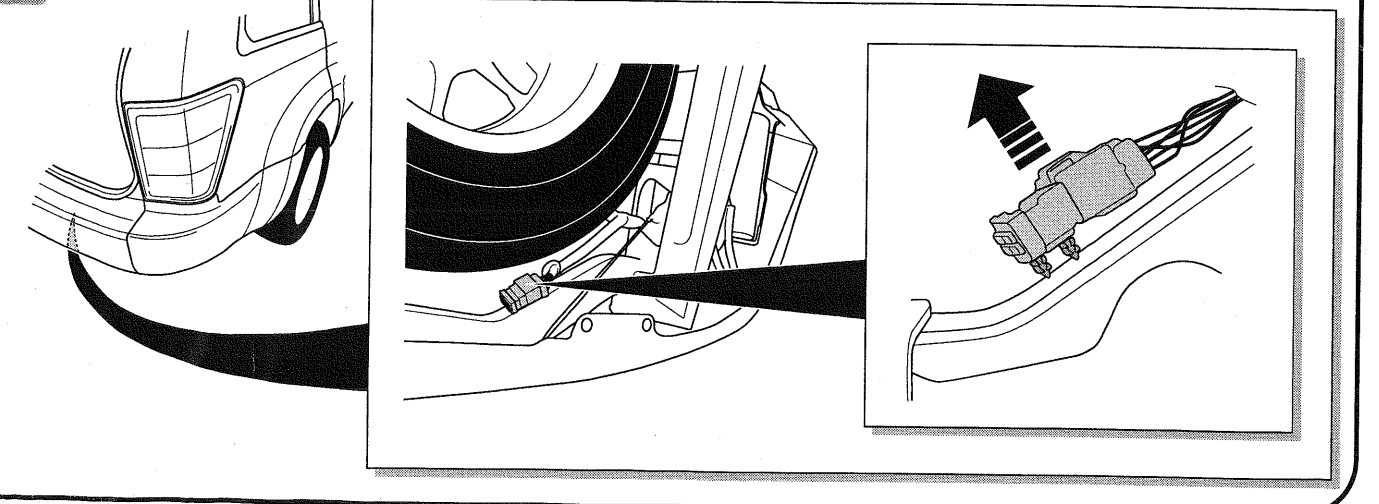

13

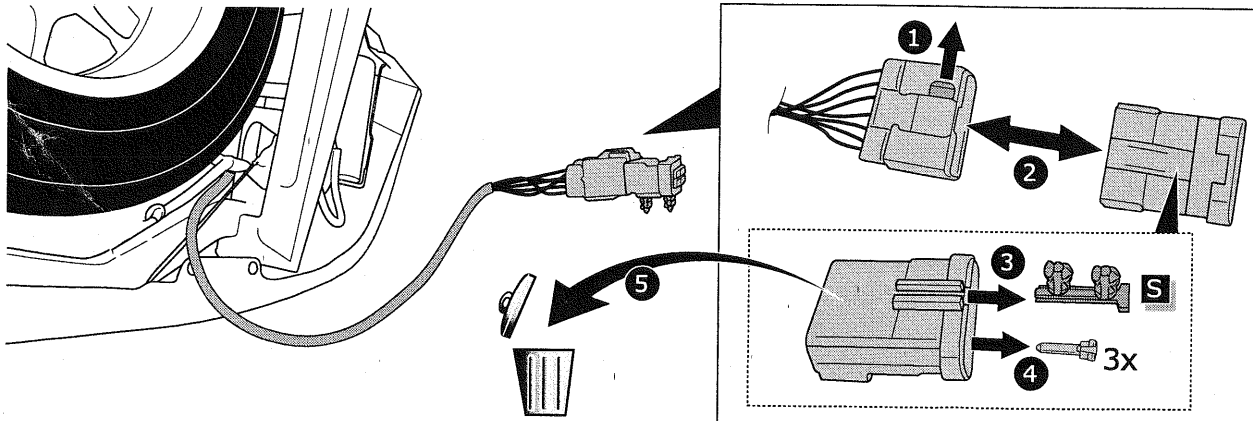

14

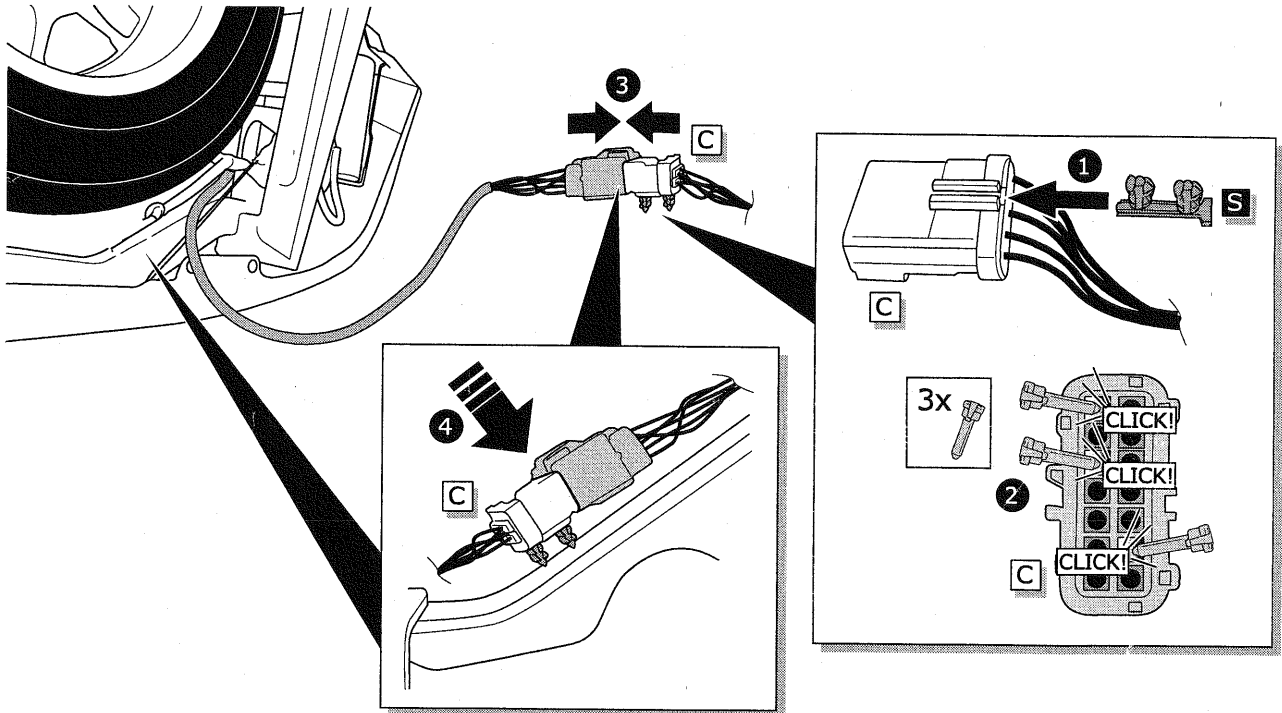

15

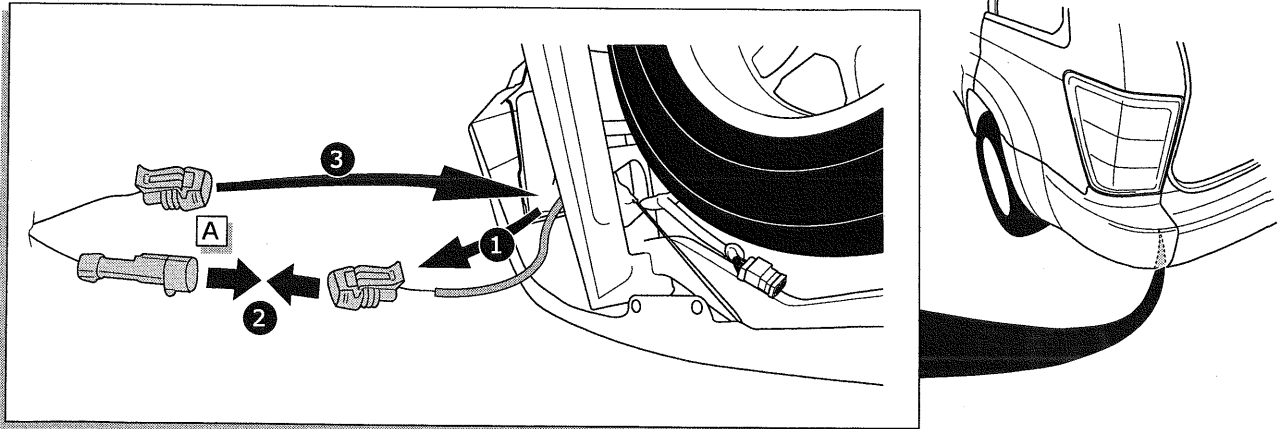

16

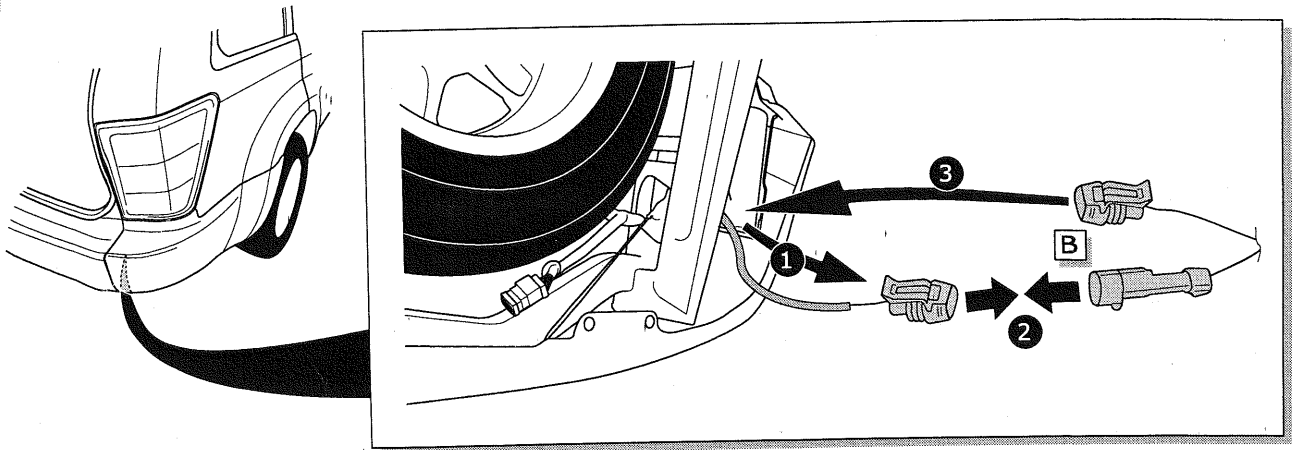

17

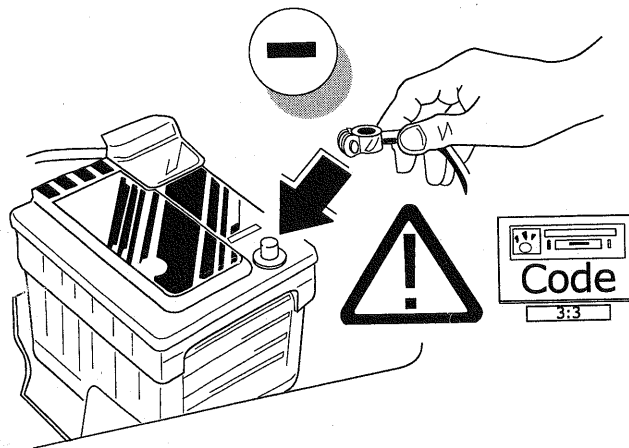

18

- DE** FUNKTIONEN KONTROLLIEREN MIT EINEM PRÜFGERÄT MIT WIDERSTAND ODER MIT LEUCHTEN MIT DER GENAUEN WATTZAHL!
- FR** CONTRÔLER LES FONCTIONS AVEC UNE BOÎTE DE TEST AVEC DE LA CHARGE OU DES LAMPES AVEC LA QUANTITÉ CORRECTE DE WATT!
- NL** CONTROLEER FUNCTIES MET EEN TESTER MET BELASTING OF LAMPEN MET DE JUISTE WATTAGE!
- GB** TEST ALL CIRCUIT FUNCTIONS WITH A TESTBOX WITH THE CORRECT POWER LOAD FOR EACH UNIT. A TESTBOX ON WHICH ONLY LEDs ARE USED CAN NOT BE USED IN THIS CASE
- ES** ¡CONTROLAR FUNCIONES CON UN TESTER CON CARGA O LUCES CON EL CORRECTO WATTAJE!
- IT** CONTROLLA FUNZIONI CON UN TESTER CON CARICO O LAMPADE DEL GIUSTO WATT-TAGGIO!
- SE** KONTROLLERA FUNKTIONERNA MED EN TESTARE MED BELASTNING ELLER LAMPOR MED RÄTT WATT-VÄRDE!
- CZ** OVĚRTE FUNKCE POMOCÍ TESTOVACÍHO BOXU NEBO SVĚTEL S PŘÍSLUŠNÝM VÝKONEM!
- DK** CHECK FUNKTIONERNE MED EN TESTBOKS, MED BELASTNING ELLER MED LYGTER MED DET KORREKTE ANTAL WATT!
- FI** TARKISTA TOIMINNOT KÄYTTÄMÄLLÄ TESTILAITE, JOSSA ON OIKEATEHOINEN KUORMITUS TAI OIKEATEHOISET LAMPUT!
- GR** ΕΛΕΓΞΤΕ ΤΙΣ ΛΕΙΤΟΥΡΓΙΕΣ ΜΕ ΈΝΑ ΚΙΒΩΤΙΟ ΔΟΚΙΜΗΣ ΜΕ ΦΟΡΤΙΟ Ή ΛΑΜΠΗΡΕΣ ΣΩΣΤΗΣ ΠΟΣΟΤΗΤΑΣ ΒΑΤ!
- NO** KONTROLER FUNKSJONENE MED EN TESTER MED BELASTNING ELLER LYSPÆRER MED RIKTIG WATTVERDI!
- PL** SPRAWDŹ FUNKCJE UŻYWAJĄC SKRZYŃKI TESTOWEJ Z OBCIĄŻENIEM LUB PODŁĄCZONYMI ŻARÓWKAMI O ODPWIEDNIEJ MOCY!

19

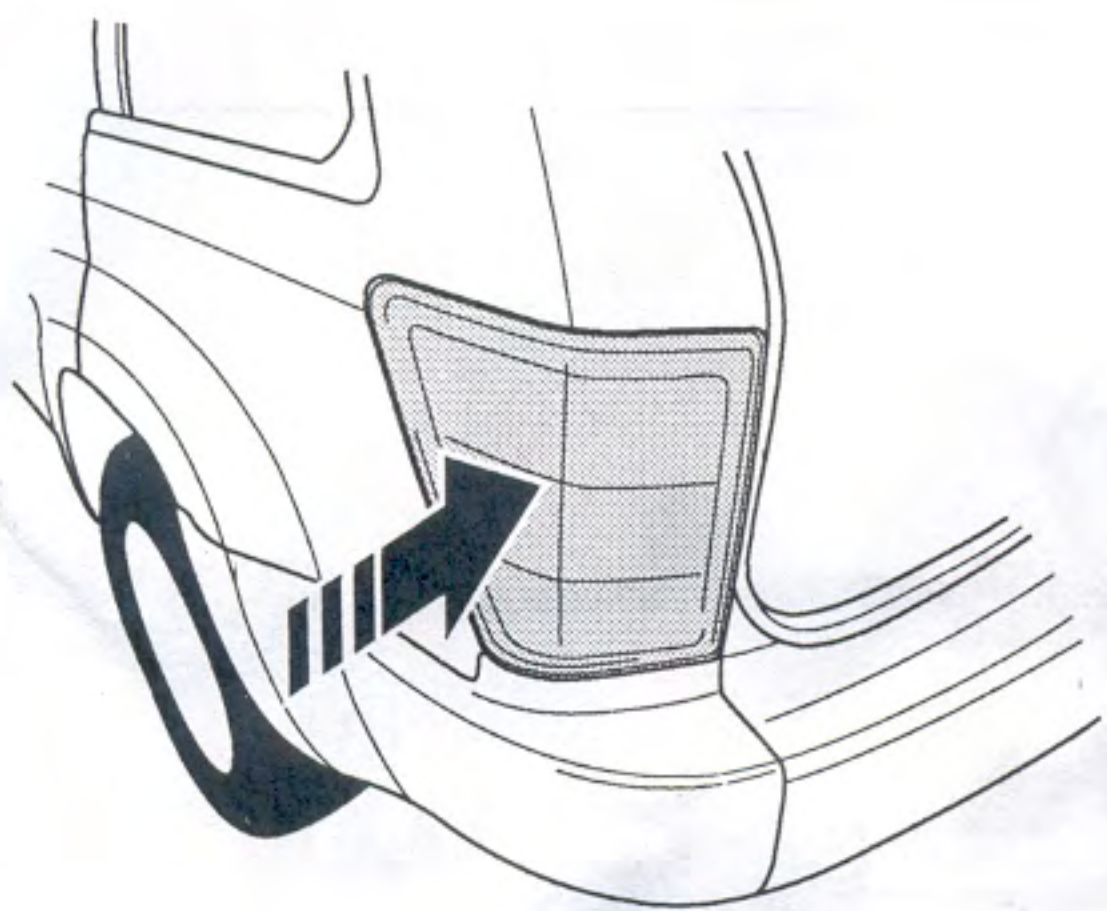

1

2

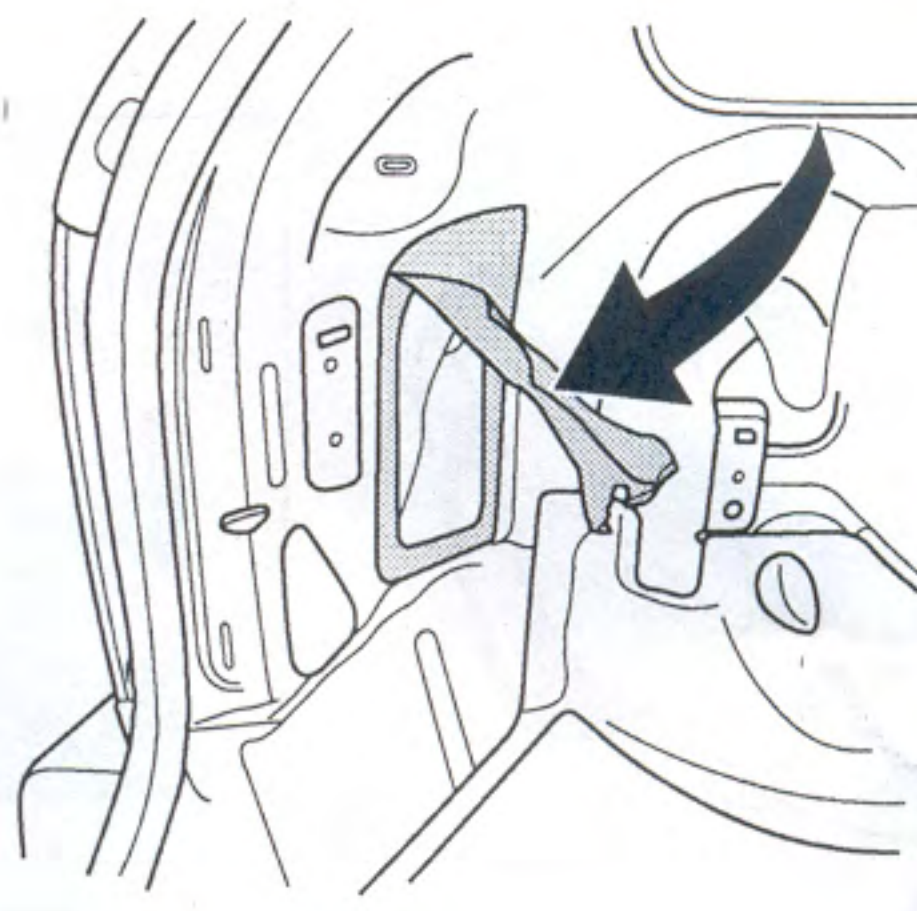

20

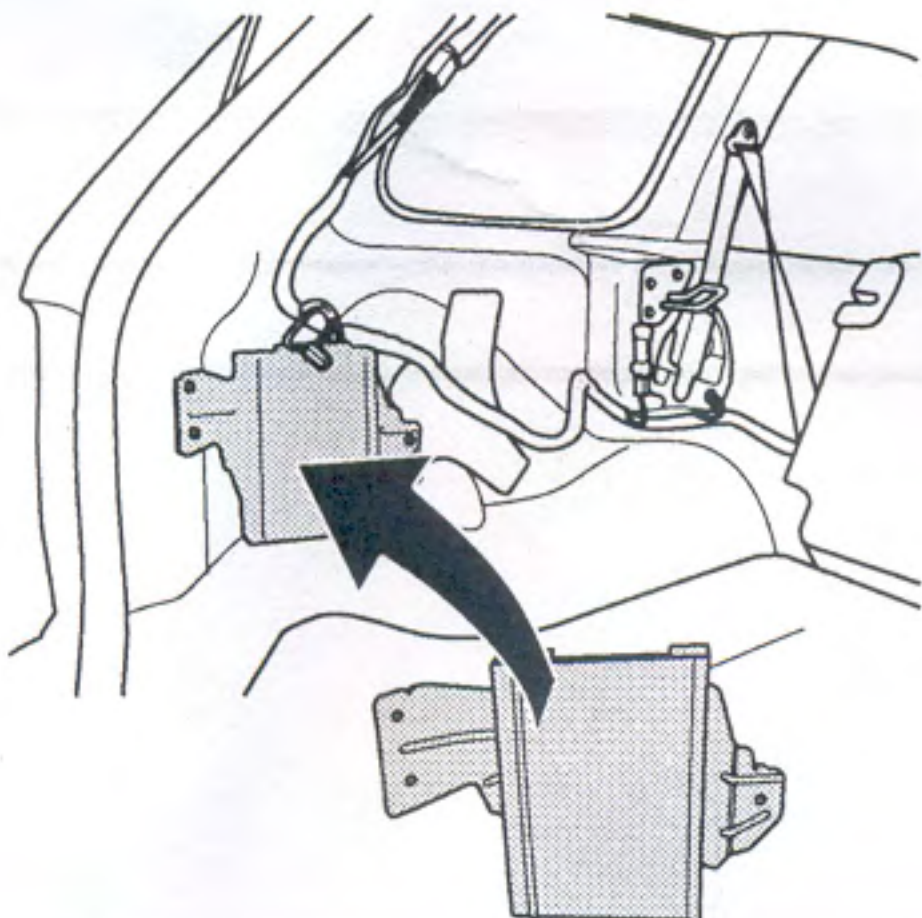

1

2

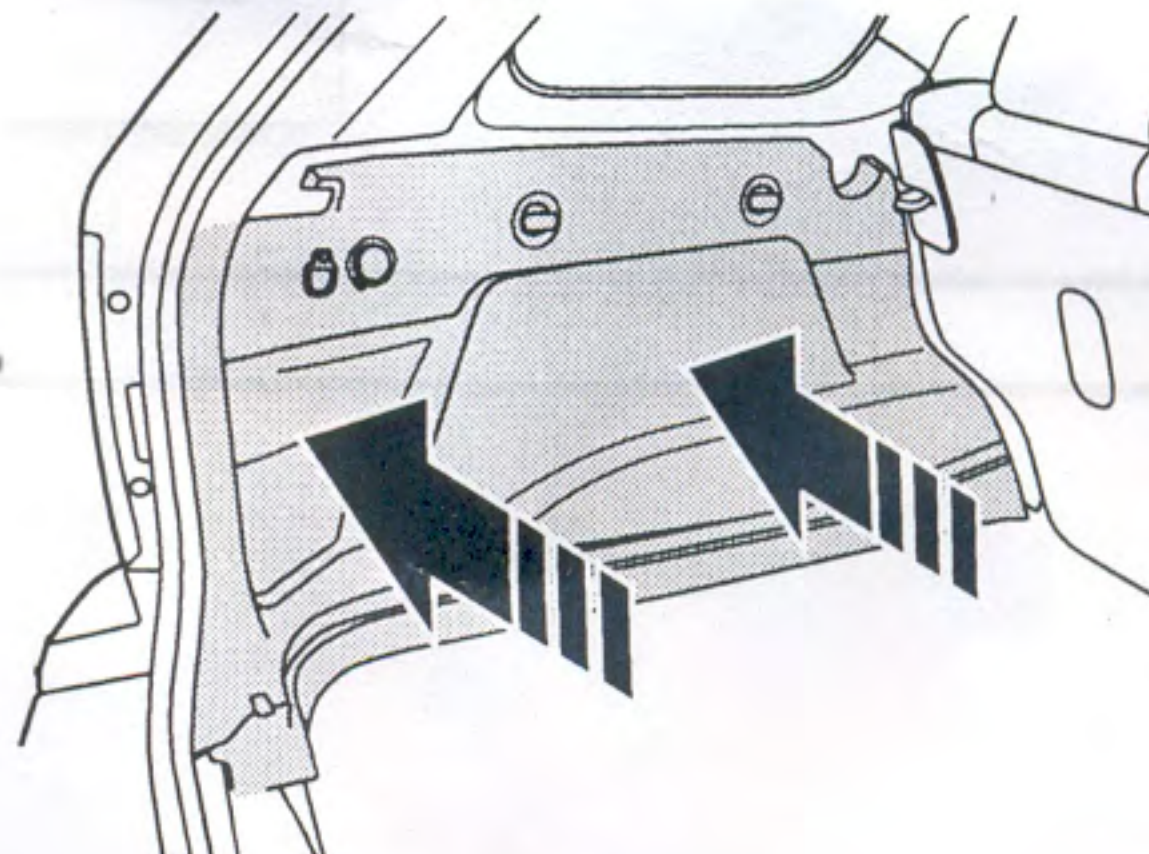

21

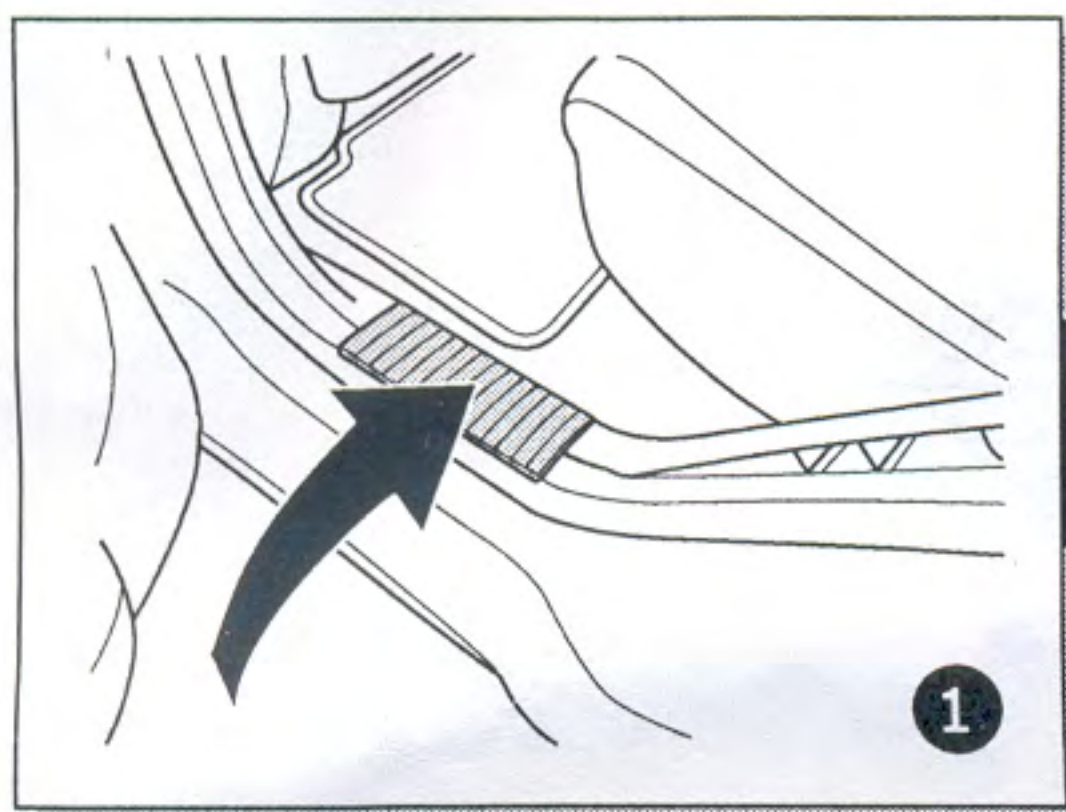

1

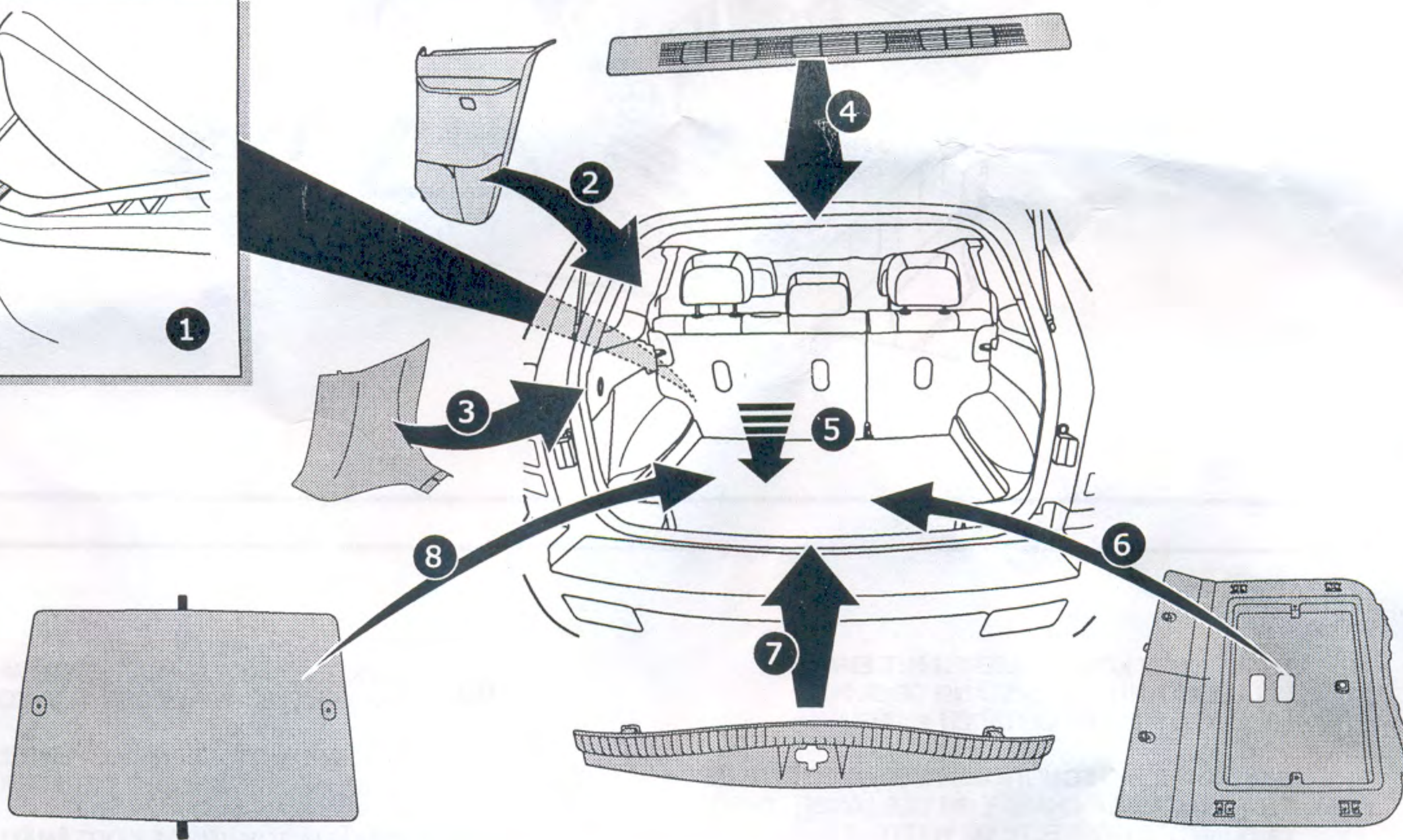

22

- Ⓛ DE Gebrauchsanleitung.
- Ⓛ FR Mode d'emploi.
- Ⓛ NL Gebruikershandleiding.
- Ⓛ GB User guide.
- Ⓛ ES Guía del usuario.
- Ⓛ IT Manuale di istruzioni.
- Ⓛ SE Bruksanvisning.
- Ⓛ CZ Uživatelská příručka.
- Ⓛ DK Brugervejledning.
- Ⓛ FI Käyttöohjeet.
- Ⓛ GR Οδηγός χρήστη.
- Ⓛ NO Brukerveiledning.
- Ⓛ PL Instrukcja obsługi.

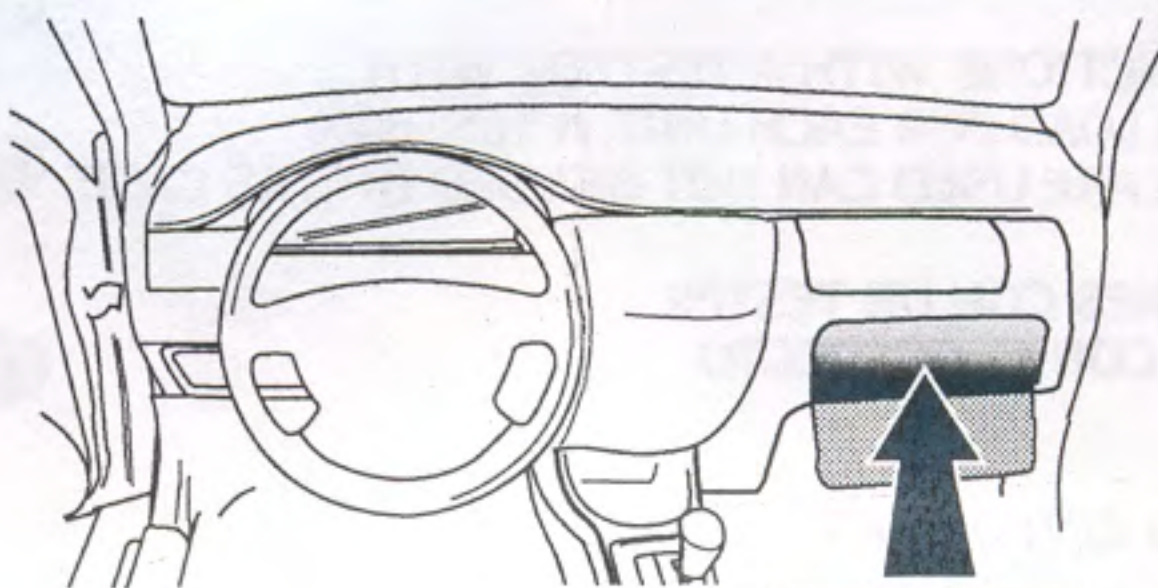

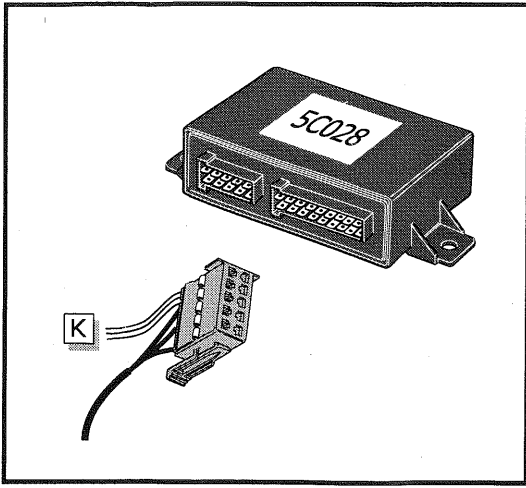

(DE) Option
 (FR) Option
 (NL) Optie
 (GB) Option
 (ES) Opción
 (IT) Opzione
 (SE) Tillval
 (CZ) Varianta
 (DK) Ekstraudstyr
 (FI) Vaihtoehto
 (GR) Επιλογή
 (NO) Eventuelt
 (PL) Opcja

1

2

Option A

Option B

Option C

9 = C

- (DE) Rot/Schwarz
- (FR) Rouge/Noir
- (NL) Rood/Zwart
- (GB) Red/Black
- (ES) Rojo/Negro
- (IT) Rosso/Nero
- (SE) Röd/Svart
- (CZ) Červená/Černá
- (DK) Rød/Sort
- (FI) Punainen/Musta
- (GR) Κόκκινο/Μαύρο
- (NO) Rød/Svart
- (PL) Czerwony/Czarny







7 = NC

- (DE) Blau/Schwarz
- (FR) Blue/Noir
- (NL) Blauw/Zwart
- (GB) Blue/Black
- (ES) Azul/Negro
- (IT) Blu/Nero
- (SE) Blå/Svart
- (CZ) Modrá/Černá
- (DK) Blå/Sort
- (FI) Sininen/Musta
- (GR) Μπλε/Μαύρο
- (NO) Blå/Svart
- (PL) Niebieski/Czarny

5 = NO

- (DE) Blau/Weiß
- (FR) Blue/Blanc
- (NL) Blauw/Wit
- (GB) Blue/White
- (ES) Azul/Bianco
- (IT) Blu/Bianco
- (SE) Blå/Vit
- (CZ) Modrá/Bílá
- (DK) Blå/Hvid
- (FI) Sininen/Valkoinen
- (GR) Μπλε/Λευκό
- (NO) Blå/Hvit
- (PL) Niebieski/Biały

- DE** Anschluss Steckdose
- FR** Connection de la prise
- NL** Contactdoos aansluiting
- GB** Socket connection
- ES** Conexión de la caja de enchufe
- IT** Allaccio zoccolo
- SE** Anslutning kontaktdosa
- CZ** Objímkový konektor
- DK** Stikdåse forbindelse
- FI** Pistorasia liitäntä
- GR** Υποδοχή σύνδεσης
- NO** Tilkobling koblingsboks
- PL** Połączenie przez gniazdo

DIN/ISO 11446	↔		1-8	↕				Reverse 			↕	↕	↕	↕
Pmax	1/L	2	3/31	4/R	5/58-R	6/54	7/58-L	8	9	10	11	13	15	19
DE	21W	2x21W		21W	52W	3x21W	52W	2x21W	180W/15Amp.	180W/15Amp.				
	Gelb	Bleu	Weiß	Grün	Braun	Rot (1,00mm)	Schwarz	Schwarz/ Rot	Braun/ Weiß	Rot (2,50mm)	Weiß	Weiß		
FR	Jaune	Bleu	Blanc	Vert	Marron	Rouge (1,00mm)	Noir	Noir/ Rouge	Marron/ Blanc	Rouge (2,50mm)	Blanc	Blanc		
NL	Geel	Blauw	Wit	Groen	Bruin	Rood (1,00mm)	Zwart	Zwart/ Rood	Bruin/ Wit	Rood (2,50mm)	Wit	Wit		
GB	Yellow	Blue	White	Green	Brown	Red (1,00mm)	Black	Black/ Red	Brown/ White	Red (2,50mm)	White	White		
ES	Amarillo	Azul	Blanco	Verde	Marrón	Rojo (1,00mm)	Negro	Negro/ Rojo	Marrón/ Blanco	Rojo (2,50mm)	Blanco	Blanco		
IT	Giallo	Blu	Bianco	Verde	Marrone	Rosso (1,00mm)	Nero	Nero/ Rosso	Marrone/ Bianco	Rosso (2,50mm)	Bianco	Bianco		
SE	Gul	Blå	Vit	Grön	Brun	Röd (1,00mm)	Svart	Svart/ Röd	Brun/ Vit	Röd (2,50mm)	Vit	Vit		
CZ	Žlutá	Modrá	Bílá	Zelená	Hnědá	Červená (1,00mm)	Černá	Černá/ Červená	Hnědá/ Bílá	Červená (2,50mm)	Bílá	Bílá		
DK	Gul	Blå	Hvid	Grøn	Brun	Rød (1,00mm)	Sort	Sort/ Rød	Brun/ Hvid	Rød (2,50mm)	Hvid	Hvid		
FI	Keltainen	Sininen	Valkoinen	Vihreä	Ruskea	Punainen (1,00mm)	Musta	Musta/ Punainen	Ruskea/ Valkoinen	Punainen (2,50mm)	Valkoinen	Valkoinen		
GR	Κίτρινο	Μπλε	Λευκό	Πράσινο	Κοκκίνο	Κοκκίνο (1,00mm)	Μαύο	Μαύο/ Κοκκίνο	Κοκκίνο/ Λευκό	Κοκκίνο (2,50mm)	Λευκό	Λευκό		
NO	Gul	Blå	Hvit	Grønn	Brun	Rød (1,00mm)	Svart	Svart/ Rød	Brun/ Hvit	Rød (2,50mm)	Hvit	Hvit		
PL	Żółty	Niebieski	Biały	Zielony	Brazowy	Czerwony (1,00mm)	Czarny	Czarny/ Czerwony	Brazowy/ Biały	Czerwony (2,50mm)	Biały	Biały		